

MEDITERRANEAN

Pollution prevention in the
Printing
and allied industries

CLEANER production

Regional Activity Centre for Cleaner Production (RAC/CP)
Mediterranean Action Plan



UNEP



Regional Activity Centre
for Cleaner Production



Ministry of the Environment
Spain



Government of Catalonia
Ministry of the Environment
and Housing

Note: This publication may be reproduced in whole or in part, for educational and non-profit purposes without special permission from the Regional Activity Centre for Cleaner Production (RAC/CP), provided acknowledgement of the source is made. RAC/CP would appreciate receiving a copy of any publication that uses this document as a source. No use of this publication may be made for resale or for any other commercial purpose whatsoever without prior permission in writing from RAC/CP.

The designations employed and the presentation of the material in this document do not imply the expression of any opinion whatsoever on the part of RAC/CP concerning the legal status of any State, Territory, city or area, or of its authorities, or concerning the delimitation of their frontiers or boundaries.

If you consider that this study could be improved or there is any lack of accuracy, we would appreciate if you could notify it to us.

Study finished in September 2003
Study published in November 2003

For additional copies or information, please contact:

Regional Activity Centre for Cleaner Production (RAC/CP)

C/París, 184, 3r
08036 Barcelona (Spain)
Tel.: +34 93 415 11 12 - Fax: +34 93 237 02 86
e-mail: cleanpro@cema-sa.org
web: <http://www.cema-sa.org>

TABLE OF CONTENTS

1. INTRODUCTION	6
2. OVERVIEW OF THE PRINTING AND ALLIED INDUSTRIES IN THE MEDITERRANEAN REGION	8
2.1. Socio-economical aspects	9
2.2. Environmental impact	13
2.3. General trends	14
3. RAW MATERIALS AND RESOURCES USED	18
4. PRODUCTION PROCESSES	26
4.1. Pre-press	26
4.1.1. Design	27
4.1.2. Film preparation	27
4.1.2.1. <i>Photocomposition</i>	27
4.1.2.2. <i>Photomechanics</i>	28
4.1.3. Film processing	29
4.1.3.1. <i>Developing</i>	29
4.1.3.2. <i>Fixing</i>	30
4.1.3.3. <i>Rinsing</i>	30
4.1.3.4. <i>Drying</i>	30
4.1.4. Typesetting and composition	30
4.1.4.1. <i>Typesetting</i>	31
4.1.4.2. <i>Composition</i>	31
4.1.5. Ozalid proofs	32
4.1.6. Making plates or printing forms	32
4.1.6.1. <i>Offset plates</i>	33
4.1.6.2. <i>Flexography plates</i>	35
4.1.6.3. <i>Letterpress plates</i>	36
4.1.6.4. <i>Screen printing screens</i>	36
4.1.6.5. <i>Rotogravure cylinders</i>	37

4.2. Printing	38
4.2.1. Offset printing	38
4.2.2. Letterpress printing	40
4.2.3. Flexography	41
4.2.4. Rotogravure printing	43
4.2.5. Screen printing	45
4.2.6. Digital printing	47
4.3. Post-press or finishing	49
4.3.1. Binding	49
4.3.2. Cutting	50
4.3.3. Folding	50
4.3.4. Gathering	50
4.3.5. Sewing	50
4.3.6. Milling	51
4.3.7. Gluing	51
4.3.8. Stamping	51
5. WASTE FLOWS GENERATED	52
5.1. Air emissions	61
5.2. Wastewater	63
5.3. Liquid waste	63
5.4. Solid waste	65
5.5. Odours	67
5.6. Noise	67
6. MINIMISATION AND ALTERNATIVES FOR POLLUTION PREVENTION AT SOURCE	68
6.1. Alternatives for reduction at source	69
6.1.1. The redesign of products	69
6.1.2. The redesign of processes	70
6.1.2.1. Raw materials substitution	70
6.1.2.2. More environmentally sound technologies or processes	76
6.1.2.3. Good housekeeping practices	85
6.2. Alternatives to recycling at source	96

7. POLLUTION CONTROL METHODS	100
7.1. Technologies for treating air emissions	100
7.1.1. Separation technologies	101
7.1.1.1. Adsorption with activated charcoal filters	101
7.1.1.2. Condensation	102
7.1.1.3. Membrane separation	103
7.1.2. Destruction technologies	103
7.1.2.1. Thermal oxidation	103
7.1.2.2. Catalytic oxidation	105
7.1.2.3. Rotary VOC concentration system	106
7.1.2.4. Absorption	107
7.1.2.5. Biological purification	108
7.2. Waste Treatment Technologies	110
8. SUMMARY DOCUMENT	111
9. SOME EXAMPLES OF THE PROPOSED ALTERNATIVES	117
BIBLIOGRAPHY	123

1. INTRODUCTION

The printing and allied industries in the Mediterranean region are characterised by the predominance of small and medium-sized companies that use various types of printing techniques on different materials. Additionally, this group of micro-companies, given their individual characteristics, tend to be located in areas that principally form part of the urban fabric.

The sector in general has a significant impact on the environment that is simultaneously a source of opportunity to improve the efficiency of these companies and the introduction of pollution prevention alternatives that exist in the sector. The Regional Activity Centre for Cleaner Production (RAC/CP) of the Mediterranean Action Plan (MAP) has thus produced this manual of *Pollution Prevention in the Printing and Allied Industries* as an instrument of technical support for companies in order to allow them to achieve greater levels of efficiency in their activities, optimising their production processes and integrating environmental considerations into company management.

The aforementioned manual has been produced by RAC/CP in collaboration with a firm of specialised consultants and an expert in the field from the region itself, Mr Rachid Nafti, who contributed the chapter containing a general description of the printing and allied industries in the Mediterranean region.

This document first outlines, in chapter 2, the situation of the printing and allied industries in the Mediterranean, providing us with an overview of its socio-economic and environmental aspects, together with general trends in the sector. Representative examples from various countries in the Mediterranean basin are provided as illustration throughout the chapter.

Following this, chapter 3 introduces the topic of raw materials and the resources used in the printing and allied industries.

Chapter 4 describes the production processes of the sector, classified according to whether they belong to the pre-press, printing or post-press or finishing stages of the process.

Chapter 5 enumerates the waste flows generated in the processes within the printing and allied industries. These may be emissions into the atmosphere, waste water, liquid or solid waste, odours or noise pollution.

Next, in chapter 6, the manual presents the opportunities available for pollution prevention at source, which are classified according to whether they are processes of reduction or recycling at source. Reduction at source consists in eliminating (or reducing) waste flows before they have been generated, either by means of modification of production processes, the application of good housekeeping practices, materials and product substitution or the use of environmentally sounder technology. Recycling at source consists of the reuse of the same waste flows that are inevitably produced, in the same process or in the same facility in which they are generated.

In chapter 7, the study presents different treatment technologies available for the correct management of waste flows generated that cannot be minimised.

Finally, a synthesis of the manual is included as chapter 8, together with some real examples of pollution prevention alternatives proposed in chapter 9, with the objective of illustrating their technical and economic viability.

2. OVERVIEW OF THE PRINTING AND ALLIED INDUSTRIES IN THE MEDITERRANEAN REGION

It could be said that printing is performed everywhere. Products bearing some form of printing are numerous and indicate the high diversity of the printing industry. This diversity concerns both the printing materials and the printing techniques. Printing is done on paper, cardboard, plastic, metal and other materials and different printing techniques applied including offset printing, letterpress printing, flexography, rotogravure printing, screen printing and digital printing.

This is also a sector distinguished by its specific characteristics, notably due to the concentration of small and medium-sized enterprises and the location of printing facilities almost everywhere within urban settlements. The particular situation of this sector makes the assessment of its socio-economic and environmental status less straightforward than in other industrial sectors. Macro-economic data related to the printing sector in the Mediterranean region often does not stand alone, but is integrated with other sectors such as paper and chemical industries. Specific data relating to the printing sector has to be searched and compiled from various sources and, in particular, from business associations as well as chambers of commerce and industry. From the environmental standpoint taken individually, printing facilities do not represent a significant impact because of their relatively small size, but taken as a whole, the printing sector exerts significant pressure on the environment if this issue is not addressed properly and without delay.

Although only a limited number of studies on this sector have been undertaken for the Mediterranean region, printing is still recognized as a strategic sector. The printing industry in the Mediterranean countries could be featured due to its important socio-economic position characterised by its total volume of goods and services, generation of employment and the fact that it represents the largest conglomeration of small businesses in the manufacturing sector. Moreover, the printing industry is considered a service industry providing products in the form of packaging to other manufacturing industries.

Furthermore, printing is an industrial sector in continuous technological evolution to meet the changing market needs and adapt and improve the printing processes for higher quality, rapidity and better control of its environmental impacts resulting from the chemical materials used and released from the production processes.

Given the unavailability of comprehensive hard data at this point from the twenty countries¹ targeted by this study, the overview of this sector is illustrated by examples and benchmarks from selected Mediterranean countries. The countries taken as examples are France, Italy, Slovenia, Egypt and Tunisia. They provide examples from countries on the northern, eastern and southern coasts of the Mediterranean and also reflect the different level of economic development, i.e. developed countries in the north represented by France and Italy, an economy in transition in the east represented by Slovenia, and developing countries in the south represented by Egypt and Tunisia. Benchmarks are used from these countries to determine the general trends of the printing sector in the Mediterranean region as a whole.

2.1. SOCIO-ECONOMICAL ASPECTS

2.1.1. Defining the printing sector

As no standard industrial classification (SIC) could be applied for all Mediterranean countries, the definition of the printing sector remains vague and differs from one country to another. In general, the printing industry is defined most broadly as firms printing by the most common processes, i.e. offset printing, letterpress printing, flexography, rotogravure printing, screen printing and digital printing, as well as newspaper, book and periodical publishers. Another aspect of this industry in the Mediterranean region is that it is not systematically classified as an independent sector but is often integrated with other branches such as the paper or chemical industry. This uncertainty in definition leads to a relative inaccuracy in the statistics on this sector, but still serves to illustrate the socio-economic and environmental conditions of the printing industry in the Mediterranean region. For this reason, benchmarks from selected Mediterranean countries² are given as examples to determine the diverse nature of this industry and its magnitude.

2.1.2. Characterization of the printing industry

In general, it is difficult to give the precise number of printing facilities in the Mediterranean region in the absence of a regional census. Besides, "in-plant" printing operations are present in facilities throughout the manufacturing sectors (such as product manufacturers that print their own labels, and manufacturers of printed circuit boards); and therefore, statistics related to printing are scattered and yet have to be mapped throughout the other sectors whenever this sector is not considered as a separate industrial sector.

¹ Albania, Algeria, Bosnia and Herzegovina, Croatia, Cyprus, Egypt, France, Greece, Israel, Italy, Lebanon, Libya, Malta, Monaco, Morocco, Slovenia, Spain, Syria, Tunisia and Turkey.

² France, Italy, Tunisia, Egypt and Slovenia.

The uncertainty regarding the number of printing facilities in the Mediterranean region does not however constitute a constraint for the characterization of this sector. In fact, one of the most significant characteristics of the printing industry is the large proportion of very small firms. Printing facilities with fewer than 10 employees constitute the overwhelming majority and could represent for example as much as 76.2%³ in France, 87.6%⁴ in Slovenia, 75%⁵ in Egypt and 64%⁶ in Tunisia. In Italy, firms with fewer than 20 workers represent 94.9%⁷. Firms with more than 100 employees are far fewer and represent 0.4% in Italy, 23% in France, 10% in Egypt, 3% in Tunisia and 2.1% in Slovenia. It is flexography and gravure printers that tend to be larger operations and have more employees.

INDICATORS	FRANCE	ITALY	SLOVENIA	EGYPT	TUNISIA
No. of enterprises	6,490	20,427	487	7,500	340
Employment, total (No. of workers)	92,000	124,857	4,391	70,533	6,848
% enterprises with <10 workers	76.2	94.9 ⁸	87.6	75	64
% enterprises with >100 workers	23	0.4	2.1	10	3
Availability of qualified labor	Average	Average	Average	Low	Low

Sources: France: FIGG, Italy: Assografici, Slovenia: CCIS, Egypt: Chamber of Printing, Binding and Paper Products, Tunisia: API

Table 1: Example of printing facilities by number of employees

Examples of production indicators from selected Mediterranean countries (table 2) indicate that the printing industry accounts for a significant proportion of the nation's goods and services, achieving a continuous rate of growth that in the year 2000 reached 34% in Egypt and around 7% in Italy and Tunisia. Moreover, in Slovenia, 20.5%⁹ of the total income of the graphic print industry is provided by direct export.

³ Fédération de l'imprimerie et de la communication graphique (FIGG).

⁴ Chamber of Commerce and Industry of Slovenia (CCIS) - Publishing and Printing Association.

⁵ Chamber of Printing, Binding and Paper Products, Egypt.

⁶ Agence de promotion de l'industrie (API), Tunisia.

⁷ Associazione Nazionale Italiana Industrie Grafiche Cartotecniche e Trasformatrici (Assografici).

⁸ < 20 workers.

⁹ CCIS - Publishing and Printing Association, Slovenia.

PRODUCTION INDICATORS	FRANCE	ITALY	SLOVENIA	EGYPT	TUNISIA
Production - year 2000 (in 10 ³ €)	8,086,000	11,516,000	160,000	530,000	137,500
Growth rate (2000/1999) (in %)	1.7	7	37	34 ¹⁰	7.1
Average annual growth over a 5-year period (in %)	0.5	2.82	13	35	2.9
Added value - year 2000 (in 10 ³ €)	4,697,966	6,679,280	-	201,400	45,375
Average growth of annual added value (in %)	2	4.5	-	7	4
Rate of added value / Production (in %)	58.1	58	-	38	33

Sources: France: FIGG, Italy: Assografici, Slovenia: CCIS, Egypt: Chamber of Printing, Binding and Paper Products, Tunisia: API

Table 2: Example of production benchmarks in Mediterranean countries

The printing sector is characterized by the existence of a large number of small enterprises applying traditional printing methods, along with a group of larger enterprises that are continuously improving their equipment and production processes. The level of technology and equipment as illustrated by examples from the region indicates that countries such as France and Italy tend to use more modern equipment and production management systems and other countries such as Tunisia and Egypt tend to use old equipment with an average age exceeding ten years and a rather poor level of maintenance. In general, technical and technological equipment in printing firms varies considerably. In Slovenia, machinery in small printing establishments is rather obsolete, while large printing companies operate with up-to-date technologies. The prevailing technology in most printing companies is the technology of offset printing, which, for instance, accounts for as much as 90% in Slovenia. Digital printing is steadily being introduced and in some countries like Italy, it is used by 5% of printers.

¹⁰ For printing on paper and flat cardboard.

TECHNOLOGY LEVEL	FRANCE	ITALY	SLOVENIA	EGYPT	TUNISIA
% of facilities equipped with modern machinery	75	55	50	30	15
Average age of machinery (in years)	7	8	10	10	15
Level of maintenance of equipment ¹¹	4	4	4	3	1

Sources: France: FICG, Italy: Assografici, Egypt: Chamber of Printing, Binding and Paper Products, Tunisia: API

Table 3: Example of technology level benchmarks in Mediterranean countries

The printing sector is also characterized by its geographic distribution and location throughout the urban fabric, and as the majority of enterprises performing printing operations are small, they could be located almost anywhere. Given that printing facilities typically serve local markets, they are most frequently located in areas adjacent to population and business centers, or in industrial parks, although smaller operations may sometimes be located in residential areas.

2.1.3. Industrial processes in the printing industry

The printing industry is characterized by a high diversity of technologies and products, and the different environmental impacts associated with them.

Overall, printing activities could be categorized within the following processes:

- offset printing,
- letterpress printing,
- flexography,
- rotogravure printing,
- screen printing,
- digital printing.

¹¹ 1: low; 2: average; 3: above average; 4: good; 5: very good.

Although the equipment applications and chemicals for each of these processes differ, they all print an image on a substrate following the same basic sequence.

The basic steps in printing are referred to as pre-press, printing, and finishing (post-press) operations. The type of printing technology that is used depends on a variety of factors, including the substrate used (e.g. paper, plastic, metal, ceramic, etc.), the length and speed of the print run, the required print image quality, and the end product.

The diversity of technologies and products in the printing industry makes it difficult to characterize the environmental issues faced by the sector as a whole. This diversity in processes will lead to different environmental concerns that are critical when developing pollution prevention and control/compliance programs.

2.2. ENVIRONMENTAL IMPACT

2.2.1. Waste generation characteristics

The printing industry generates several types of waste chemicals that can add up to become a considerable problem in a very short time. The main types of wastes in the printing industry include:

- **Air emissions**, mainly consisting of emissions of volatile organic compounds (VOC) from the use of cleaning solvents and inks, as well as alcohols and other wetting agents. Larger plants can be a source of NO_x and SO₂ emissions. Some substances may cause unpleasant odours or affect health and the environment.
- **Wastewater** from printing operations may contain lubricating oils, waste ink, cleaning solvents, photographic chemicals, acids, alkalis, and plate coatings, as well as metals such as silver, iron, chromium, copper and barium.
- **Solid wastes** consist of environmentally hazardous wastes such as photographic and residual chemicals, metal hydroxide sludge, dyestuffs and solvent residues, cleaning rags containing dyes and solvents, oil spills, materials past their use-by date, test production, bad printing or spoilage, damaged products, and also bulky waste such as paper.
- **Noise** comes principally from fans, printing presses, and transport.

2.2.2. Environmental standards applicable to the printing sector

Although there is no specific or sectoral environmental regulation applicable to the printing sector as such, the latter is ruled by the general legal framework on environmental protection that is applicable for the control and prevention of industrial pollution in all countries of the Mediterranean region. Standards for air emissions, discharge of wastewater and solid waste management, where available, are applicable.

2.3. GENERAL TRENDS

The printing industry is an entity unlike almost any other. It is an industry that provides services for other manufacturing industries, it is dominated by SMEs, and the average printing facility is small (< 10 employees). It is also an important player in terms of economic outputs and employment. Indeed, the thousands of enterprises constituting this sector employ thousands of people and account for a significant proportion of the nation's total volume of goods and services.

Taken individually, the printing companies are usually not a major environmental concern. But when the industry is examined as a whole, comprising thousands of enterprises, we face an entirely different situation where the cumulative impact of the pollution generated by this industry makes it a considerable environmental issue to be effectively addressed.

The environmental impacts created by the printing industry will not disappear on their own and without action, and will simply become much more unmanageable every year if appropriate pollution prevention and control measures are not taken in the short run.

The reading of the following benchmarking table allows for the definition of the profile and trends of the printing sector, which is represented by the following characteristics:

- The specific features of this industrial branch are quite striking as evidenced by the table of benchmarking related to employment figures, as well as the market and revenues generated:
 - In France, only 152 enterprises have a turnover of more than 5 million euros and 19,257 achieve a turnover of less than 5 million euros.
 - In Italy, the statistics concerning employment in this industrial branch show that of 20,427 enterprises, 19,385 enterprises employ fewer than 20 people. However enterprises employing more than 20 employees account for 41.2 % of total employment.

- In Egypt, 10% of total enterprises employ more than 200 people but account for 75% of total turnover of this sector.
- In Slovenia, companies employing more than 100 people represent 2.1% of total enterprises but account for 57.7% of total employment.

- The dominant activity in this sector is bookwork printing¹² and constitutes the largest market share representing 89% in France, 65.3% in Italy, 78% In Egypt, 76.2% in Tunisia, and 69% in Slovenia¹³, followed by the other activities relating to pre-press, finishing and newspaper printing.

- This industrial branch is by far dominated by Small and Medium-sized Enterprises (SMEs). Enterprises with fewer than ten employees represent 87.6% in Slovenia, 76.2% in France, 75% in Egypt and 64% in Tunisia. In Italy, 94.9% of the enterprises have fewer than 20 employees.

- SMEs constitute a major asset and a real economic and social strength. In France, for instance, enterprises employing fewer than ten persons account for 75% of total employment, 75% of the industry turnover and 96% of total production.

- In Slovenia, 20.5% of income from the printing sector is contributed by direct export.

- This sector is expected to face some competitive pressure from non-print media, such as CD-ROM and other electronic means of transferring information.

The printing sector in the Mediterranean region presents specific characteristics inherent to the high number of SMEs that constitute the backbone of this sector. The opportunities related to its continuous development remains dependent on the capacity of adaptation and innovation of the sector to face new challenges related to new market demands as well as the minimization of its environmental impact by applying pollution prevention and cleaner technologies.

The printing industry is in fact too big to be ignored on all fronts: economic, social and environmental.

¹² All printing work except newspapers, magazines and printing on flat cardboard.

¹³ Books and brochures, newspapers, advertising materials and forms.

PRINTING SECTOR BENCHMARKING TABLE¹⁴

INDICATORS	FRANCE	ITALY	SLOVENIA	EGYPT	TUNISIA
1. PRODUCTION INDICATORS					
Production - year 2000 (in 10 ³ €)	8,086,000	11,516,000	160,000	530,000	137,500
Growth rate (2000/1999) (in %)	1.7	7	37	34 ¹⁵	7.1
Average annual growth over a 5-year period (in %)	0.5	2.82	13	35	2.9
Added value - year 2000 (in 10 ³ €)	4,697,966	6,679,280	-	201,400	45,375
Average growth of annual added value (in %)	2	4.5	-	7	4
Rate of added value / Production (in %)	58.1	58	-	38	33
2. ENTERPRISE INDICATORS					
No. of enterprises	6,490	20,427	487	7,500	340
Total employment (No. of workers)	92,000	124,857	4,391	70,533	6,848
% of enterprises with < 10 workers	76.2	94.9 ¹⁶	87.6	75	64
% of enterprises with > 100 workers	23	0.4	2.1	10	3
Availability of qualified labour	Average	Average	Average	Low	Low
3. TYPE OF ACTIVITY					
Commercial printing (bookwork printers) (in %)	89	65.3	69 ¹⁷	78	76.2

¹⁴ France: FIGG, Italy: Assografici, Egypt: Chamber of Printing, Binding and Paper Products, Tunisia: API, Slovenia: CCIS.

¹⁵ For printing on paper and flat cardboard.

¹⁶ < 20 jobs.

¹⁷ Books and brochures, newspapers, advertising materials and forms.

INDICATORS	FRANCE	ITALY	SLOVENIA	EGYPT	TUNISIA
4. PRODUCTION MANAGEMENT					
% of companies with Computer - aided production management	50	40	50	2	0
Production automation ¹⁸	4	3	3	2	1
Production planning	4	4	4	4	3
% of companies with quality control	55	50	50	3	3
Factory organization and layout	4	4	4	3	2
5. TECHNOLOGY					
% of facilities equipped with modern machinery	75	55	50	30	15
Average age of machinery (in years)	7	8	10	10	15
Level of maintenance of equipment ¹⁹	4	4	4	3	1

¹⁸ 1: low, 2: average; 3: above average; 4: good; 5: very good.

¹⁹ 1: low, 2: average; 3: above average; 4: good; 5: very good.

3. RAW MATERIALS AND RESOURCES USED

In this section we will mention the main raw materials and the necessary resources used in the printing and allied industries. Subsequently we will explain the production processes used for each type of printing, so that it will be easier to identify the source of the waste flows generated and analyse the possibility of establishing pollution prevention measures.

One can define the term *printing* as being the reproduction of texts and/or images a certain number of times by means of the transfer of inks (colouring substances) onto a material (support) using a printing method.

As can be understood from the definition, the main raw materials used in the printing and allied industries are the inks and the printing supports. Furthermore, the photographic films, the chemicals for processing photographs, printing plates and others, which will be described further on, are also considered as raw materials.

Below we also explain the properties of each of these raw materials, in order to know their main features and thus be able to establish the appropriate environmental criteria for pollution prevention in the production processes of the printing and allied industries.

Support: is any material used to which images or graphics (texts or illustrations) are transferred using printing methods and inks. Some of these materials are shown in the following table:

SUPPORT	MOST USED TYPES OF MATERIALS	PRODUCTS MADE	USUAL PROCESSES
Paper and cardboard	A great variety of paper types	Newspapers, books, encyclopaedias, advertising leaflets, magazines, envelopes....	Offset, flexography, letterpress and digital printing systems
Plastic	Polyester, polyethylene, polyvinyl chloride (PVC) or polypropylene, polystyrene and nitrocellulose	Cards, labels, packaging, shopping bags, ribbons, stickers, toys, accessories...	Flexography, rotogravure
Textiles	Cotton, acrylics, nylon, wool or mixed fibres	T-shirts, sports clothes, mountain wear, umbrellas, banners, flags	Screen printing
Metal	Aluminium, steel, copper, bronze, iron	Cans, lids and tops for drinks, preserves, plates, batteries, outdoor signs, ID badges and kitchen utensils	Screen printing
Glass and ceramics	Glass and ceramics	Glasses, plates, mirrors, cosmetics packaging, jewellery and glass in general	Screen printing

From the above information, it is worth mentioning that paper is the most-used support by far, as the majority of printing is done on this material. There are a great variety of paper types; up to 457 different types are used. The varieties depend on a series of physical characteristics that make the paper suitable for different uses; grammage, texture, moisture, etc., all set the conditions for the type of printing. The paper format varies depending on requirements, comes in rolls or in loose sheets, and it is available in different sizes.

Inks: Substances that are applied to the support to reproduce the image on the plate. There are different types of ink with different characteristics, the properties of which make each of these inks most suited to a specific type of support.

Printing inks can be classified into two large groups, in accordance with their type:

- **Oil-based inks** which are made from oils and varnishes and are mainly used in offset and letterpress printing. In this case, the ink applied dries on the substrate, mainly by penetration or solidification (by precipitation, oxidation, polymerisation, solidification of the melted state, radiation).

• **Liquid inks** which are made from varnishes and solvents. In addition, the liquid inks can be classified into two further groups, depending on the solvent:

- The *solvent-based liquid inks* which are used in flexography, rotogravure and screen printing. The ink dries on the substrate, mainly through the evaporation of a volatile component (organic solvent).
- The *water-based liquid inks* which are mainly used for printing on paper and cardboard. The ink dries on the substrate by absorption, and is consequently slower than solvent-based inks.

There are also other types of ink used less frequently, such as radiation- cured inks (UV and EB), which have applications in offset, letterpress printing and flexography.

- **UV inks:** are special inks that contain monomers and pre-polymers that polymerise due to the action of a light sensitive substance (a photo-initiator) which absorbs the ultraviolet radiations to start a virtually instantaneous hardening reaction. The monomers in the ink act as a solvent of the pre-polymers and what is different from the classic ink drying systems, is that the monomers do not evaporate.
- **EB inks (electron beam):** EB inks are similar to UV inks; they do not contain organic solvents and offer the same advantages. EB radiation is a beam of electrons generated by an electric current flowing through a conductor. It has the disadvantage that it damages the paper and also makes it necessary for the operators to wear protection against the X-rays that are generated.

The composition of the main types of ink described is shown in the following table:

COMPONENTS	OIL-BASED INKS	LIQUID INKS
Vehicle	Mineral and/or vegetable oils and/or natural or synthetic resins	Natural or synthetic resins
Solvent	Petroleum fractions or aliphatic hydrocarbons with a high boiling point	Solvents with a low boiling point
Pigments and colouring agents	Organic or inorganic	Organic or inorganic
Additives	Varied	Varied

As can be seen, the inks are made by mixing a coloured material that is dissolved or dispersed in a vehicle or varnish; the chemical composition of each one of these components is variable, depending on the type of ink, and is comprised of:

- The **vehicle or varnish** has a different composition, depending on whether it is intended for manufacturing liquid inks or oil-based inks. In the first case it is made from synthetic resins (based on phenol, vinyl, nitrocellulose, etc.) or natural resins (animal or vegetable, for example pine rosin), and organic solvents or water. The varnishes for the oil-based inks also contain resins and, in addition, vegetable (soybean, sunflower, etc.) or mineral oils (obtained from petroleum).
- The **solvent** is different and is found in different concentrations, depending on the type of ink. Those most used are:
 - For the manufacturing of *oil-based inks*, the petroleum fractions or aliphatic hydrocarbons with a high boiling point (220-275° C) are used, with a concentration of less than 10%.
 - The solvents for the *liquid inks* that are used for flexography and rotogravure can be used in concentrations of up to 65%, and may be of the following types: alcohols, aliphatic naphtha, esters, ketones, glycol ethers or aromatic hydrocarbons. Highly volatile solvents (with a boiling point starting at 50° C) are used in inks for flexography and rotogravure, and solvents with a boiling point of around 150° C in the inks for screen printing.

In no case is it usual to use organochlorine solvents.

The water-based liquid inks may replace the solvent with water, although they may also have an organic solvent content of between 5 and 10%.

- The **pigments and colouring agents** are those that confer the colour quality (black, white, colour) to the ink, and organic pigments are mainly used (in 50% of cases), although inorganic pigments and colouring agents may also be used.* To reduce the intensity of the colour and change the rheology, extender pigments are used (barytes, calcium carbonate, etc.).

The inorganic pigments may contain highly toxic heavy metals (mercury, cadmium, lead, chrome; lead chromium being the most harmful), although their use is low due to health and environmental legislation; the main types of metals used are iron, titanium and zinc. The pigment used in black inks is carbon black.

The pigments that are normally used come as a dry powder, although they can also be moist or in a liquid state.

- The types of **additives** that are used for manufacturing printing inks are the following:
 - *Dryers*: These catalyse the oxidation of the drying oils in some oil-based inks. They may contain heavy metals (cobalt, manganese or lead).
 - *Waxes*: Give resistance to the abrasion and scratching of the inks. Some of those used are: polyethylene, hydrocarbons, vegetable and animal waxes.
 - *Antioxidants*: Delay the premature oxidation of the ink in the press. Some examples of antioxidants are: di-phenyl-amine, phenyl-beta-naphthyl-amine.
 - *Other*: Lubricants, dispersants, anti-foaming agent, thickeners, wetting agents, retardants, surfactants.

Essentially, the final composition of the ink must be the most suited to the formulation of resins and oils, as supported by the additives and solvents that lend it the desired properties, depending to a large extent on the final support the ink will be printed on.

The containers in which the oil-based inks are supplied vary from 1 to 1.5 kg and the liquid ones from 18 to 1,000 kg.

Other raw materials used in the printing and allied industries are the following:

Photographic films: the support on which images are formed by projecting light onto a photosensitive layer. Photographic films consist of a plastic base, normally made of acetate or another polymer, on which there is a fine layer of emulsion in which photosensitive silver halide crystals are embedded (silver bromide or silver iodide). The films are supplied in packets from 25 units to 100 or more.

Chemicals for the photographic process: these are the liquids used for processing photographic films. They are used in different phases: in the first phase the photographic film is submerged in liquid developer, consists mainly of reducing substances, where the film is transformed into a visible image in the areas exposed to light; in the second, the film is submerged in a fixing liquid, which eliminates the silver halide salts that were not exposed to light and were not developed. Finally, water is used for the final rinsing thus avoiding the deterioration of the film.

- *The developer*: alkaline solutions that are supplied in containers from 10 to 60 litres. The chemical composition of developers varies, although it is normally formulated using a mixture of inorganic salts, diluted in water. The majority of developers contain hydroquinone, a noxious substance which has possible carcinogenic effects²⁰.
- *The fixer*: acid or slightly acid solutions that are supplied in containers from 10 to 60 litres. The chemical composition of fixers varies; they are normally formulated using a mixture of organic and inorganic acids and inorganic salts diluted in water.

Printing plates: or the printing dies are the carriers of the image, and are elements that are prepared in such a manner that they make possible the transfer to the support of the colouring materials to replicate texts and/or illustrations. There are plates of different materials with the printing elements in relief, engraved or at the same level as the non-printing areas; the plates are obtained by different procedures and are used for different printing techniques.

The plate materials for the main types of printing are:

TYPE OF PRINTING	MATERIALS
Offset plates	Aluminium or polyester with a superficial photopolymer emulsion
Flexography plates	Rubber or photopolymers
Letterpress plates	Photopolymers, metal
Screen printing screens	Synthetic (polyester, nylon) or metal (stainless steel or phosphorous bronze)
Rotogravure cylinders	Iron or steel coated with copper and/or nickel with a chrome protective layer

Chemicals used in platemaking: the procedures for obtaining the different types of plates are different, and therefore so are the chemicals used.

The main chemicals used for processing plates with a sensitive or photosensitive surface are:

- *Developer*: solutions that are supplied in containers from 10 to 200 litres. The solutions consist of a reducer, normally an alcohol, an alkaline substance and a mixture of inorganic salts diluted in water.

²⁰ According to the *International Chemical Safety Cards*, a substance that may possibly have irreversible effects (R40).

- *Gumming agent*: an acid solution consisting mainly of water and in a lesser amount by dextrin, inorganic acids and benzene derivatives.
- *Plate corrector liquids*: acid solutions comprising organic liquids, inorganic acids and thickening compounds.
- *Plate cleaning liquids*: acid solutions containing oils, hydrocarbons, glycols, organic and inorganic acids and mainly water.

In the specific case of screens for screen printing it is also possible to use photosensitive emulsions, degreasing agents, descaling agents, fixers, cleaning chemicals, catalysers, solvents, adhesives and so on.

In the specific case of the cylinders used for rotogravure, the chemicals are significantly different from the above:

- *Cylinder cleaning*: chemical cleaning by means of caustic soda or hydrochloric acid.

Fountain solution: an aqueous solution used to wet the plates that use oil-based inks in order to make the ink repellent to the areas that are not to be printed. In general, this solution is basically comprises:

- Water that has normally received a calcium and/or ion removal treatment prior to its use in order to avoid the formation of streaks during stoppages, causing problems in the application of the ink.
- Isopropyl alcohol present in an approximate concentration from 5% to 15% (it is added to increase the humectant power of the water; this additive facilitates printing as it reduces the surface tension of the fountain solution).
- Additives with buffer properties (maintaining the pH between 4.8 and 5.5 by increasing the water affinity of the non-inked areas and avoiding the formation of deposits) such as phosphates, citrates or tartars, and finally moisture-absorbent salts, surfactants, fungicides and algaecides.

Generally, the fountain solution is refrigerated in order to reduce the water-ink emulsification, and at the same time afford the maximum prevention of alcohol evaporation.

Cleaning products: the presses are cleaned once printing has finished or when a colour change is required, as the cylinders, the trough or the valves remain impregnated with unusable inks. The cleaning of these parts is done with rags and pieces of rag impregnated with organic solvents, or with detergents and water in the case of water-based inks. The cleaning frequency is defined by different factors, such as the amount of dried ink, the accumulated quantity of paper fibres and threads, production changes and the amounts and types of ink.

The most usual solvents are ethylene acetate, ethyl alcohol, n-propanol, isopropanol, toluene, methyl ethyl ketone (MEK), methyl isobutyl ketone, isopropoxyethanol and xylol.

Post-press or finishing: the binding process requires the use of adhesives, covers, threads, etc.

4. PRODUCTION PROCESSES

In general, the stages that configure the production process of the printing and allied industries are as follows:

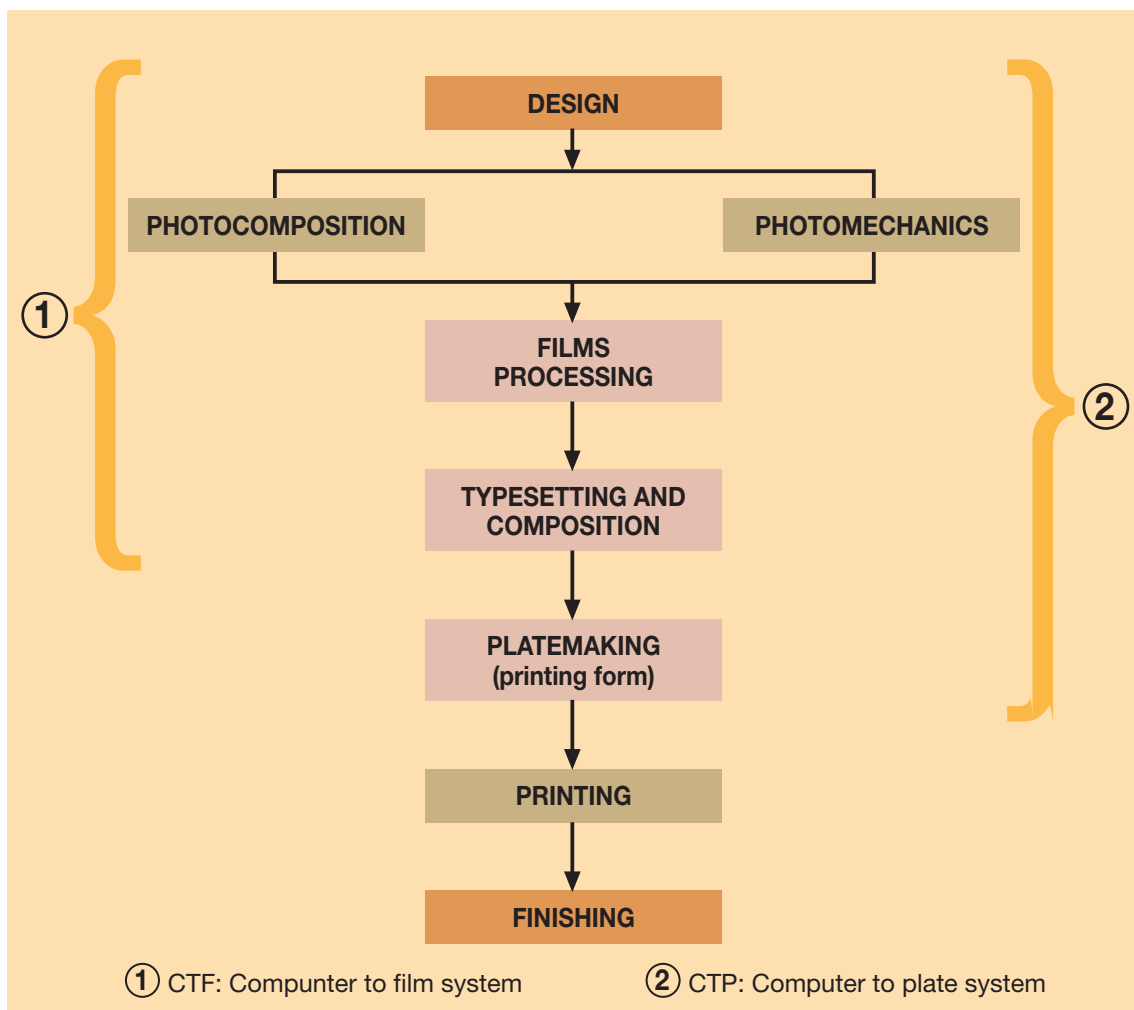

Figure 1: Stages of the printing process

4.1. PRE-PRESS

Consists in a series of tasks required to obtain the printing plate or printing form, which transfers the image to the support. It is necessary to know each one of these in order to subsequently analyse the most suitable pollution prevention methods.

These tasks are carried out in different phases as described below:

4.1.1. Design

Constitutes the first phase of the pre-press process. It is a creative phase in which the graphic designer tries to reflect his/her ideas or those of the client so that the product may appropriately fulfil the function for which it was developed.

The success of the product largely depends on this phase, as the design is essential to any visual product as the message to be transmitted is etched on the retina of the target public. Once the design is available, the image is captured on a support.

4.1.2. Film preparation

This second phase includes the necessary operations for obtaining the films. The design that has been made by the graphic designer is prepared so that it can be printed and subsequently manipulated.

Up until relatively recently, all these operations were carried out manually and mechanically by means of the photocomposition, photomechanics, film processing and typesetting and editing operations. Presently the use of computer applications and electronics has introduced a large number of new advantages and possibilities, resulting in reduced work time and improved results.

This is so much so that the main part of pre-press process is presently carried out on the PC, so that the image is scanned, inserted on the screen with the text, edited and sent to the printer to view the test images, or it is filmed in order to obtain films.

In any event, all the conventional treatments for obtaining films are still valid today and comprise the following operations:

4.1.2.1. Photocomposition consists in defining the text to appear in printed format. Nowadays this work is done by computers, as these benefit from having ever more sophisticated programs with more advanced performance features. These programs offer great versatility when making modifications, allowing for the preparation of compositions, and for presenting compositions of the same text making slight changes in the type of letters, their body, colour, etc.

Once it is considered that the final text has been obtained, it is sent to be filmed to obtain the film.



Film

4.1.2.2. Photomechanics are the procedures for manipulating the image. The photomechanics workshop works with the images so that the photographs, illustrations, drawings and graphs are obtained in the proper sizes, the desired number of colours in the specific colour hues and with the right amount of brightness.

As is done for photocomposition, the image is sent to be filmed in order to obtain the film.

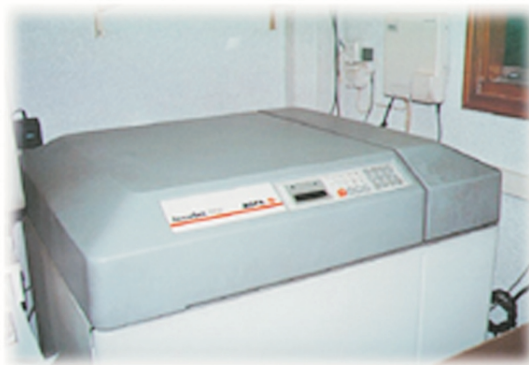

Filming machine

Proofing is a constant in all the printing processes and photocomposition and photomechanics are no exception. Before obtaining the film, the images may be sent for printing, in order to carry out the required quality control, and, if necessary, make any pertinent corrections.

As has already been mentioned, the film is obtained by using the filming machine. The filming process is quite similar to the printing process, and only the support and system are different:

1. With the software used for photocomposition and photomechanics, the work is printed in the film camera, where the output options can be configured: size and characteristics of the desired resolution.

2. The filming machine consists of two essential parts: the camera itself, which treats the film with a laser, and the RIP, a computer that collects the information that has been sent. The RIP stores all the files that are to be handled, until they are processed to be filmed. The camera recovers the data from the RIP, consisting of bits of information, and processes it, converting these bits into letters and images.
3. The film advances and the laser exposes the film in printing and non-printing areas.
4. Finally, the film is stored or else passed directly on to the processor.

4.1.3. Film processing

This is done once the films with the texts and the images have been obtained.

The processor is the machine used for automatically carrying out a series of operations required for processing the films. The film is passed through a series of baths, successively carrying out the developing, fixing, rinsing and drying processes. These operations must be carried out under certain specific conditions, and at all times the developing liquids and their pH, must be controlled. Working in non-ideal conditions leads to faulty films with excessive or inadequate developing.

The state of the rollers through which the film passes must also be inspected, as if they are misshapen or worn they may lead to photolithographs with some areas that are developed and others that are not.



Film processor

The operations carried out during developing are described below:

4.1.3.1. Developing: is the phase in which the film, on entering into contact with the developer, transforms the areas that have been exposed to light into a visible image. This transformation is achieved by reducing the exposed silver halide crystals into silver metal. The non-exposed crystals remain unchanged.

During this transformation the developing bath becomes oxidised and loses its reducing capacity, thus gradually losing its developing action on the film. On the other hand, the bromide ions released by the film become a part of the solution, also impairing the action of the reducing agent. It is therefore necessary to regenerate the bath with precise quantities of fresh liquid, depending on the surface area of the film developed.

In addition to the regeneration, there are also other factors that affect developing, such as temperature, the time and the agitation. In other words, depending on the developer, there is an ideal temperature for a specific amount of time, within which one must maintain a specific concentration and ensure a complete and even contact of the liquid with the film.

4.1.3.2. Fixing: in this second processing phase, the film is submerged in the fixing bath and where the silver salts that have not been exposed to light and have not been developed are eliminated. This area is the image area for negative film and the non-image area for positive film. This bath deposits the silver released by the film and also the small amounts of developer carried over from the previous phase.

As in the case of developer, in order to ensure proper fixing, it is important to work at the optimal temperature shown for the fixing liquid, for a specific amount of time, and also to maintain a specific concentration. It will therefore also require adequate regeneration based on the surface area of the film used.

4.1.3.3. Rinsing: this phase is essential in order to ensure the preservation of the film over time. In the rinsing process, all the soluble compounds originated during the developing process are eliminated, as well as the traces of fixer carried over by the film, which in the long run would make it turn dark.

A humectant can be added to the rinsing water in order to reduce the surface tension and perform a more efficient rinse. As in the two previous operations, the optimum temperature, time and rinse water regeneration should be maintained.

4.1.3.4. Drying: is the last phase in the processing of the film, and is carried out by means of hot air without any type of chemical agent.

4.1.4. Typesetting and composition

Is the phase where the photographic material of the text and the photographic material of the illustrations are combined to obtain an original to be reproduced.

4.1.4.1. Typesetting is the set of operations carried out to present the texts and illustrations that have been generated, and where these are laid out to obtain the desired design within the format of the page to be printed. It is always carried out on transparent millimetric paper, typesetting the layout directly onto the sheet itself, which is subsequently used for composition.

4.1.4.2. Composition is the operation where the films of the texts and illustrations are laid out and adhered to the typesetting on the composition sheet. It is done with mathematical precision and these elements are fixed using adhesive tape (glues are also used when there is insufficient space to use tape). This operation is carried out on a backlit table and is meticulously reviewed to check that the result obtained is as desired.

In general, a composition sheet is used for each colour: it is recommended to review the sheet before starting the composition in order to ensure that the sheet is flawless.



Typesetting and composition operations

Computer-to-Film (CTF) system:

As can be seen from figure 1, the CTF system saves some of the phases required in the more traditional production process. Thanks to different software applications available on the market, the composition operations can be done on a computer screen and from there be passed on directly to the filming machine, where a film is generated that can be directly passed on to the printing forms preparation section.

There are composition programs that allow for the editing of texts with the insertion of images and graphic elements, allowing for complete control over each element. Once the composition is complete, any changes considered necessary can be made, so that if one wishes to change a part of the text, or the size, or the font or the planned layout, it will only be necessary to open the file where the document has been stored and carry out the pertinent changes.

There are also imposition programs that enable the pages to be worked while directly preparing the folding, in the corresponding order and with the required position and orientation, so that it can be directly sent to the filming machine to obtain the film, with which the manual typesetting and composition of each separate page, is avoided.

Once the film has been obtained, the plates are exposed and then processed. This saving in the process, consequently involves savings in time and money.

Logically, in order to work with this system (CTF) where the films are directly printed from the computer to the filming machine, a suitable pre-press environment is necessary, requiring a computer with the appropriate page composition and imposition programs, a laser printer for carrying out the necessary tests and a graphic output filming machine with the minimum necessary dimensions, in order to cater for the format required by the client.

4.1.5. Ozalid proofs

Even though these proofs are very practical for checking images before passing them onto the printing plate, the use of ozalids has decreased over time and as all of the pre-press process is becoming digitalized; these are being replaced by digital proofs. Ozalids are copies and compositions and photolithographs, in paper format, that are necessary to be able to verify the measurements and the texts that appear, for example, on packaging, and that are very often used for acceptance testing for a manufacturing order of a new product.

In the preparation process of the ozalid, an imposition of the image is made by means of a specific projector onto special ferrocyanide paper, which is photosensitive and has the capacity to change colour in the presence of ammonia vapour. The system used is hermetic, so that the ammonia vapours are filtered, removing the impurities from the pure ammonia, and the solvent is used until it is spent, so, that its consumption is actually extremely low.

4.1.6. Making plates or printing forms

This is the last phase before printing. In this phase the image carrier is prepared, which consists of plates made of different materials and printing forms. The principle used to transfer the ink to the support is what differentiates the type of printing. In the description of the platemaking processes, the offset printing plates are described first and subsequently the remaining printing plate types.

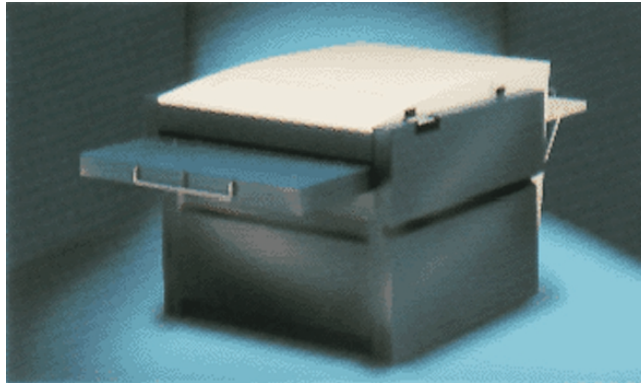

Platemaker

4.1.6.1. Offset plates: The offset plates are a key part of the printing process as they are the elements that carry the image. The plate transfers the image onto a rubber blanket, which in turn transfers it to the printing support. (Therefore, the image goes directly to the plate, it is indirectly passed onto the blanket and it is finally directly printed onto the support).

These plates have a photosensitive coating; the physical properties of this coating vary with exposure to light, so that when exposed to it, printing and non-printing areas are generated; this difference is conferred by the physicochemical (oil and water affinity) properties of the surface of the printing plate.

Whereas the printing area has oil affinity, having affinity for oily substances such as the ink, the non-printing area has water affinity and has affinity for aqueous substances, thus making the transfer of the image possible. This differentiation is achieved through exposure to light.

Exposure is the usual process where the photosensitive plate is passed through an exposure unit, transferring the film image onto the plate. This machine accelerates the exposure process as it radiates a light frequency that is greater than that of sunlight. The procedure is as follows: A film or photolithograph (composition sheet containing the image) is placed on the plate, always taking into account its correct positioning, as the light must reach the plate through the photolithograph. When the photolithograph is in place on the plate, the assembly is inserted into the exposure unit, and before it is closed, the exposure time is set, which varies depending on the specific characteristics of the unit and the plate. The exposure unit is closed and a vacuum forms to ensure better contact and the film is exposed to an ultraviolet light, thus leaving the image on the plate.

Platemaking: in the same manner as the photosensitive carriers of text and images are taken to be developed, once they have been exposed to light, the offset plates must be developed. It is for this reason that they are put into a platemaker or a bath of developer.

In the platemaker, the plate is first submerged in a developer bath in order to dissolve the non-image area of the sensitive layer and give the image areas ink affinity. Afterwards, the plate is removed from the developer bath; it is then rinsed with water and is subjected to a gumming agent. The purpose of this gumming is to protect the plate. After the gumming process and while it is still in the processor, the plate is dried by means of hot air.

Once the plate is removed from the processor, it is time to carry out another inspection in order to detect possible errors and correct them. The corrections are made manually using a special pencil and correcting fluids that have a strong etching action on the sensitive layer. The sooner errors are detected, the better, as any treatment after developing acts as a protector and slows down the corrections.

There is a final treatment which consists in heat hardening, which is a heating process that extends the life of the positive plates in the presses and improves the chemical resistance of the image areas. If this treatment is carried out and the gumming agent is applied once again, the number of printings can be quadrupled.

Computer-to-Plate (CTP) system:

This system is encompassed within the technological innovations of the printing and allied industries, and is to a great extent a technological continuation of the CTF system, although it goes a step further.

With CTP the printing plate is obtained directly from the order given by the computer, in other words, it saves all the intermediate steps that make up the pre-press procedures of less technologically advanced systems. The CTP system can be used for making offset, flexography and rotogravure plates.

It is a system that has revolutionised the printing industry as it offers total consistency in platemaking. In order to use this system it will be necessary to have a complete digital pre-press environment.

The basic configuration of a CTP is made up of different computers connected to the electronic imposition and the digital composition systems, a scanner for the input of information, a control console and temporary storage for pages, an interpreter or RIP (converts the image received into a bitmap which constitutes a complete image formed by pixels of known values for the output device), a positioning testing device, a reproduction device that includes a platemaker and a networked connection of all these electronic elements.

This system offers a series of advantages as explained below:

- The production cycle is shorter and therefore less time is required to carry out a given task. The saving of operations in the procedure normally implies a saving in time and money, in other words it leads to higher productivity.
- The suppression or decrease in the use of all the chemical agents and materials used in the intermediate stages. It should be taken into account that not everyone implements a complete CTP system for obtaining offset plates, nor do those that have one stop using their conventional system entirely, either because there are still remaining originals in film format, or having only one plate maker, the conventional system can serve as a backup system in case the platemaker is busy or out of order.
- Savings in labour are obtained as operations such as manual typesetting and composition and imposition of individual pages and placing in the presses, are eliminated.
- The suppression of errors in intermediate stages leads to a saving in materials, time and consequently, money.
- CTP technology enables stochastic layout: the reproduction with very fine points and without a geometric structure eliminates a series of problems such as the lack of detail or interference with the geometric structures of the image.
- This system involves a significant improvement in printing quality, as the points etched on the plate are much more precise and sharp, which allows for much more reliable and constant response at print time.

Having said this, it is also worth mentioning some of the disadvantages of the CTP system.

- In order to start replacing the conventional system for obtaining offset plates with the CTP system and have a completely digital workflow, it is worth considering digitalising the existing films or the new analogical ones that clients may bring.

4.1.6.2. Flexography plates: Flexography plates are flexible printing plates made of a photopolymer or rubber. The first flexography plates were made of rubber, a material that is still used for certain applications; however the great advantages photopolymer plates offer have led to these being the ones that are now used the most.

Being flexible, when the plate is placed on the cylinder, it stretches on its outside surface and shrinks on its inner surface; this distortion must be taken into account when preparing the film.

The image forms are in relief, which causes the distinction between the printing and non-printing areas, which are at different levels.

Platemaking: photopolymers are plastic materials that are sensitive to UV light. The photopolymer flexography plates are prepared using a direct light process.

A negative is placed on a photopolymer sheet and it is exposed to UV rays. The negative film acts as a mask that only allows the UV rays to penetrate into the image areas. In the parts exposed to UV light, the photopolymer polymerises, in other words, it hardens and becomes insoluble, whereas the photopolymer that is protected from the UV light, remains uncured. After exposure, the plate is developed using a specific solvent in order to remove the non-exposed material. The polymerised material remains as an image in relief which forms the printing surface on the plate. Afterwards, the rinsing process is carried out by means of a rinsing solution, which is normally water, to eliminate any residue of photopolymer or contaminated liquid, and then to finish, the plate is dried to eliminate the rinsing solution.

4.1.6.3. Letterpress plates: These plates have the image shapes in relief, which causes the distinction between the printing and non-printing areas, which are at different levels.

Letterpress plates are made of metal or photopolymer. The photopolymer plates are the same as flexography ones, but are harder. In general, they are made in virtually the same as flexography plates.

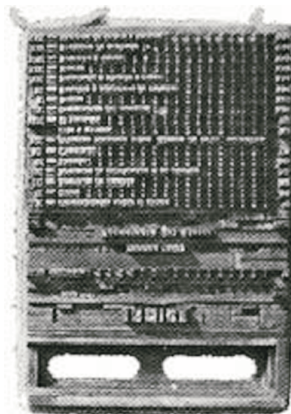

Metal letterpress form

4.1.6.4. Screen printing screens: Before these screens were made of a piece of cloth stretched within a wooden frame, nowadays they are made of a mesh woven with very fine metal threads or with synthetic fibres attached to a wooden or metal frame.

The printing form comprises the screen through which the ink is transferred directly to the support. The screen has selective permeability: in the printing areas it is permeable to the inks and in the non-printing areas it is impermeable.

Screenmaking: there are different methods for transferring the image to the screens, the most usual being to use photosensitive emulsions directly. This type of screen transfer is

done by spreading a layer of liquid emulsion onto the screen, then drying it and exposing it to light in contact with the film.

On being exposed to light, all the areas intended for printing must be blocked on the photolithograph and must be made opaque to light, whereas the areas that are not to be printed, must be transparent, in other words, they must let the light pass through. Thus, the blocked areas of the photolithograph correspond to the image that will subsequently be printed. In the developing process with water, the non-exposed areas wash out, whereas the exposed parts are hardened with exposure and become fixed to the cloth. Finally, the screens are dried.

4.1.6.5. Rotogravure cylinders: The rotogravure printing plates are metal cylinders coated with a fine layer of copper and nickel. The printing method with these plates is an etching which forms cells, in other words the outside surface does not retain ink, and therefore does not print, while the printing surface comprises the etching, of varying depth, on these cylindrical surfaces. Thus, the different level of the printing and the non-printing areas is the unique feature of this type of printing.

Platemaking: firstly, the cylinder is cleaned so that it is perfectly polished. This cleaning can be done mechanically by using a special millstone or chemically by submerging the cylinder in a bath with caustic soda or hydrochloric acid.

In a second phase, the cylinder is submerged in the preparation baths, in which the copper layers (coppering) and the nickel layers (nickeling) are deposited on the iron or steel cylinder.

Next, the excess copper is removed by means of a turning and polishing process and finally the image is etched on. There are different techniques for etching: in the nitric acid process it is etched directly onto the metal and in another the image is transferred by using an original drawing.

The nitric acid technique consists in coating the metal plate with an acid-resistant substance and then eliminating the parts that we wish the image to be etched onto. Next, it is subjected to a corrosive bath until the image appears to be sufficiently etched.

Nowadays there are more modern techniques for etching the cylinder; the work is completely computerised, starting with the design, it is etched by means of the impression cylinder using a diamond (CTP).

Finally, the cylinder is chromed in order to increase its resistance to wear.

4.2. PRINTING

Once the printing form has been obtained, it can be used for transferring the image onto the desired graphic support, it is at this time that the printing stage starts.

The main types of printing are described below.

4.2.1. Offset printing

Offset printing is characterised by the image being transferred from the printing plate to the paper by means of a rubber element called the *blanket*, in other words the printing is done indirectly.

The printing form is flat and there are therefore no noticeable differences in level, as the differentiation between the printing and non-printing areas is determined by the physical-chemical properties of the printing plate. The printing area can be determined due to its lipophilic nature, and therefore its affinity for oily substances such as ink, and the non-printing area by hydrophilic nature, due to its affinity for aqueous substances.

It is for this reason that the offset plates must be wetted using a fountain solution specifically prepared to enhance the attraction of the fountain solution, and obviously the repulsion of the ink. An important point and a characteristic of the wetting system is the so-called water/ink balance that must be determined for each plate and type of ink in order to obtain a final product of quality. Thus, an excess of fountain solution may produce a solution/ink mixture which will be "over-emulsified". On the other hand, if the amount of water used is insufficient, this may lead to insufficient water affinity in the non-printing area, leading to oily areas. A suitable fountain solution avoids problems such as oxidation and the formation of streaks on the cylinders during stoppages, and it also allows control the mechanical effects of the printing machine, and the types and degree of interferences caused by dust on the paper and emulsified ink particles. The fountain solution is not simply water. The solution, in addition to controlling the aforementioned aspects, must also maintain a constant fine film of water on the surface of the plate, which means that it needs:

- a minimum of wetting agent, normally isopropyl alcohol, which increases the viscosity of the fountain solution
- a buffer solution to keep the pH constant between certain predefined values, for example from 4.8 to 5.5
- an antioxidant to avoid oxidation during press stoppages
- an agent to prevent the formation of algae and fungi
- an anti-emulsion effect for each type of ink.

Generally, the fountain solution is refrigerated in order to reduce water/ink emulsion, which decreases the surface tension of the water, thus avoiding the evaporation of the alcohol to the maximum.

Essentially, an adequate fountain solution determines the printing quality, and the choosing of the most suited one is therefore a delicate task.

During the printing process, the ink is passed from the ink fountain onto the paper by means of an inking train which has the main purpose of transferring the continuous, even quantity of ink to the plate, as required for printing. Within the assembly of this inking train is the ink fountain, which contains the ink, and the battery of cylinders, which transfer the ink to the plate.

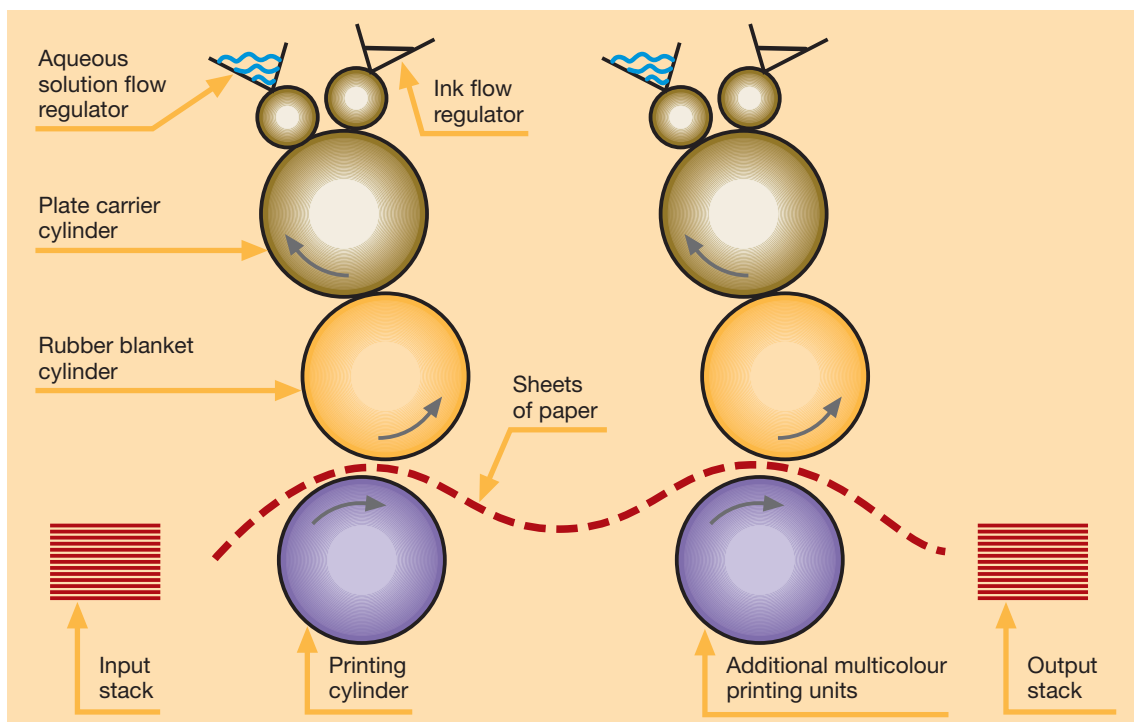
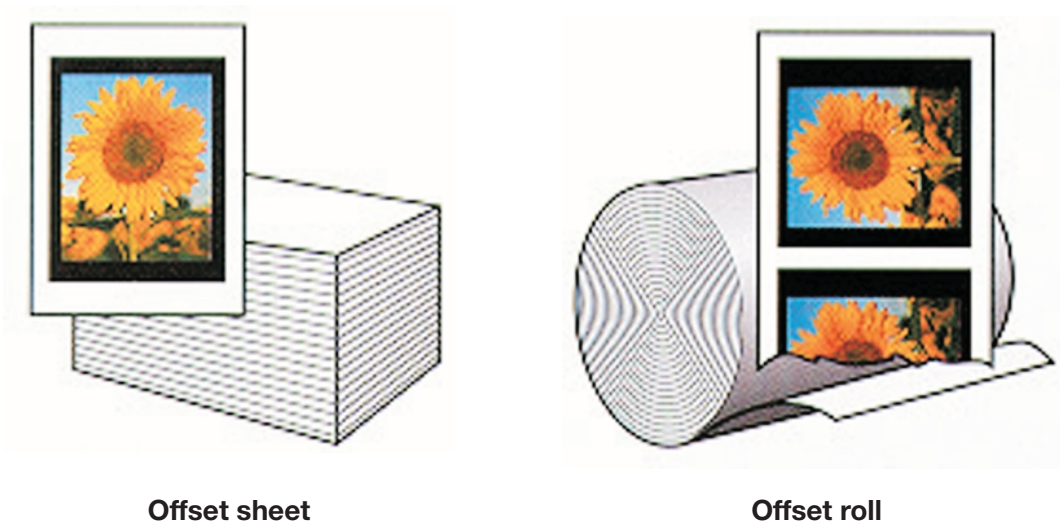

Diagram of the offset system

Thus, the offset printing procedure is centred on the printing plate, where the fountain solution and the ink are applied, so that the ink is retained on the parts of the plate that have an affinity for oil and is repelled by the parts that have an affinity for water; this repulsion being enhanced by the action of the fountain solution.

When the plate has picked up the ink, it transfers it to the rubber blanket and this cylinder is the one that prints the image on the paper or support that passes over the impression cylinder.

Once the support has been printed, the drying stage starts, which can be done, according to the type of machine, ink and support, with either cold or hot air, or infrared or ultraviolet radiation.



There are different types of offset printing: Cold-set-web-offset (cold system roll feed system), heat-set-web-offset (heat drying roll feed system) and sheet-fed-offset (sheet feed system). The first two are normally used for printing magazines, newspapers and other products using high-speed production. The sheet-fed-offset is used for printing many products, such as books, posters, leaflets of all types and others in which quality is more important than speed.

4.2.2. Letterpress printing

There are many different types, as this was the first printing process and was consolidated in the mid 15th century, immediately after Gutenberg invented the press for printing movable characters²¹.

²¹ *Artes Gráficas* by E. Martín, Ediciones Don Bosco Barcelona 1975.

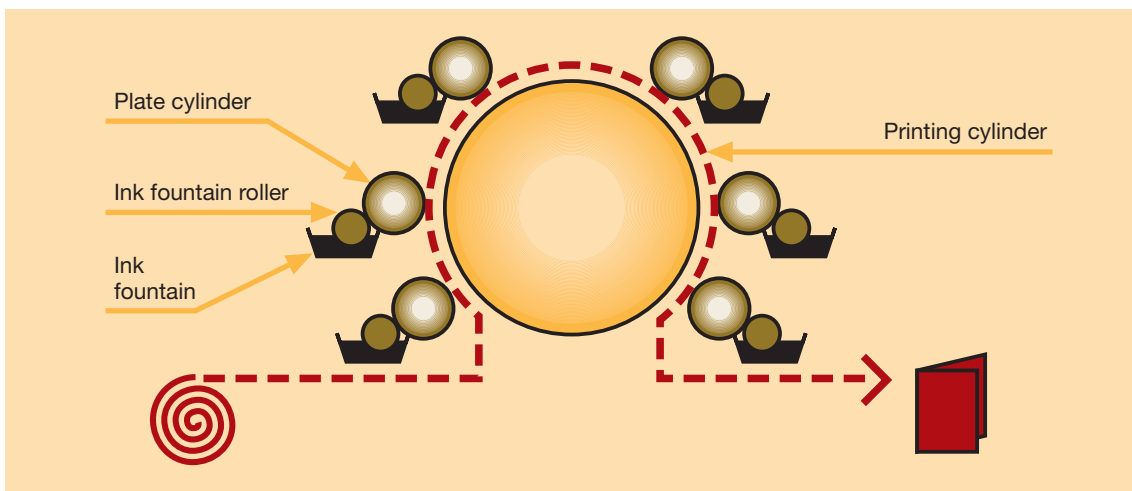

Diagram of a letterpress roll printing system

Letterpress printing is a direct printing procedure that uses raised images (plates) made of photopolymers, for carrying out the printing, as well as a thick ink, similar to the one used for offset printing.

The image transfer is carried out by the impact of the ink-impregnated form onto the printing support.

It is a method that has been a milestone in the progress and evolution of printing, and consequently in the printing and allied industries, even though presently it is in steep decline, as productivity is quite low compared to other printing methods.

The most widespread is direct letterpress printing, which is presently used for short print runs, above all for the printing of office materials and similar applications. In the past, newspapers, books, etc. were printed using this technique.

4.2.3. Flexography

Flexography is the printing method with rotary press raised image which uses plates or stencils of highly-resilient flexible material, and quick-drying fluid inks, with evaporation by means of hot air, or, as in the offset system, by using infrared or ultraviolet radiation.

In general, the ink is transferred by an inking cylinder to the transfer cylinder, located above the plate cylinder, which inks the surface of the stencil or flexography plate. The ink is transferred by contact onto the support to be printed, which in turn is pressed by the impression cylinder, as shown in the attached diagram. The ink transfer system in flexography.

In its most simple and common form, flexography depends on four main parts:

- *The inking cylinder:* the inking cylinder is generally covered in rubber. It picks up the ink from the ink fountain and transfers it to the ink transfer cylinder.
- *The transfer or anilox roll:* is the cylinder that regulates the ink flow, and is made of metal or metal sheathed with ceramic, etched over its entire surface with extremely small cells. The purpose is to cover, in a controlled and measured way, the printing plates attached to the plate cylinder with a fine layer of ink.
- *Plate cylinder:* carries the plate with the image and it is located between the anilox roll and the impression cylinder. The anilox roll transfers the measured film of ink to the surface in relief or the one above the level of the plate, which in turn transfers the ink to the support surface.
- *Impression cylinder:* used to support the substrate.

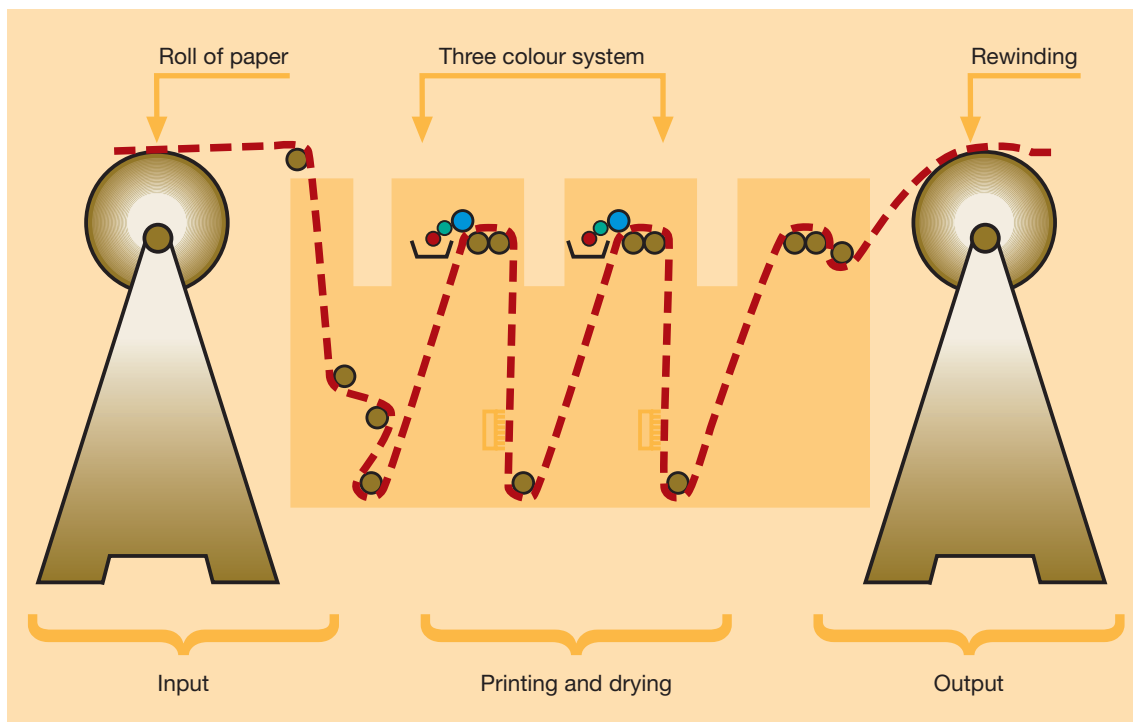

Diagram of a roll-fed flexography system

It is a form of letterpress printing the uses a flexible photopolymer or rubber printing plate in a rotary press. It is mainly used to print plastic containers, corrugated paper, cardboard, paper bags, labels, paper for wrapping food products and industrial uses, shower curtains...

In general, the quality of the work is good but not excellent, due to the tendency of the fluid ink to spread over the support, and also due to the forms used that do not allow fine detail.

4.2.4. Rotogravure printing

The print form is engraved on the cylinder. Thus the surface to be printed is the inner one, constituted by the engraving, whereas the outside surface is not to be printed and does therefore not retain the ink.

The depth of the engraving implies that the amount of ink that will adhere to the support in the deepest areas will be greater and will therefore generate a more intense colour, and on the other hand the colour intensity will be lighter in the places where the engraving is less deep.

This system confers very bright colour tones and contrast effects to the printed work, which are difficult to achieve with other printing techniques that feature a more even intensity in the colouring of the different points.



Engraved cylinder and impression cylinder

The rotogravure printing system basically comprises three elements: the roll unwinder, the printing unit and the roll rewinder.

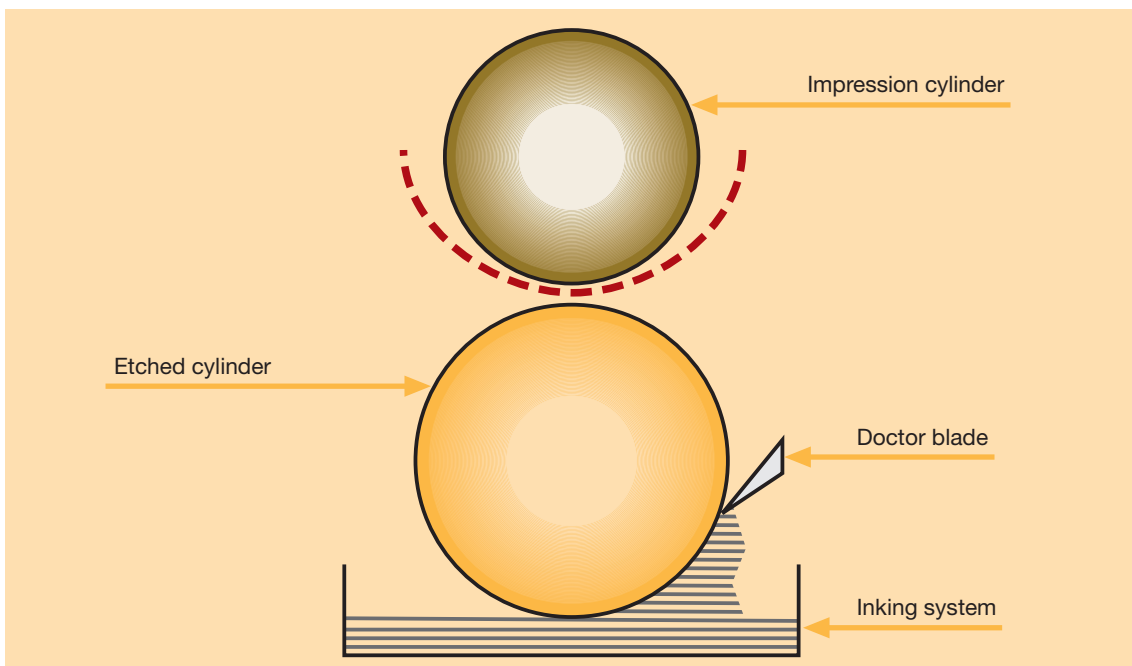

Rotogravure inking system

There are very different machines, and which type is used depends on the product requirements and demands.

With regard to the printing unit, where the printing takes place, this consists of the following elements:

- *Etched cylinder*: the cylinder that is etched, and it therefore picks up the ink for the printing areas and transfers it to the support being printed.
- *Impression cylinder*: located above the etched cylinder and is used to press the support onto the etched cylinder so that the ink flow is the best possible.
- *Inking system*: is the system that makes it possible for the ink to be deposited on the etched area of the printing plate. It comprises the ink fountain and the cylinders that pick up the ink.
- *Doctor blade or knife*: physically removes all the ink deposited on the surface of the engraved cylinder, leaving only that which remains in the etched cells of the cylinder, which constitutes the image that will be printed on the support. It is therefore essential for obtaining the object image from the printing form.
- *Drying chambers*: located between printing units to evaporate the ink solvent charge from the surface of the material that has just been printed in order to ensure that it arrives dry at the next printing unit, and that the printing process can continue correctly. This drying can be carried out with hot air, or by infrared or ultraviolet radiation.

Thus, the process starts with one colour of ink on the engraved cylinder and the subsequent removal of the excess surface ink by the doctor blade, so that ink will only remain in the etched area, which is the printing area.

Once the image has been printed it is then dried in order to continue the process with the remaining colours.

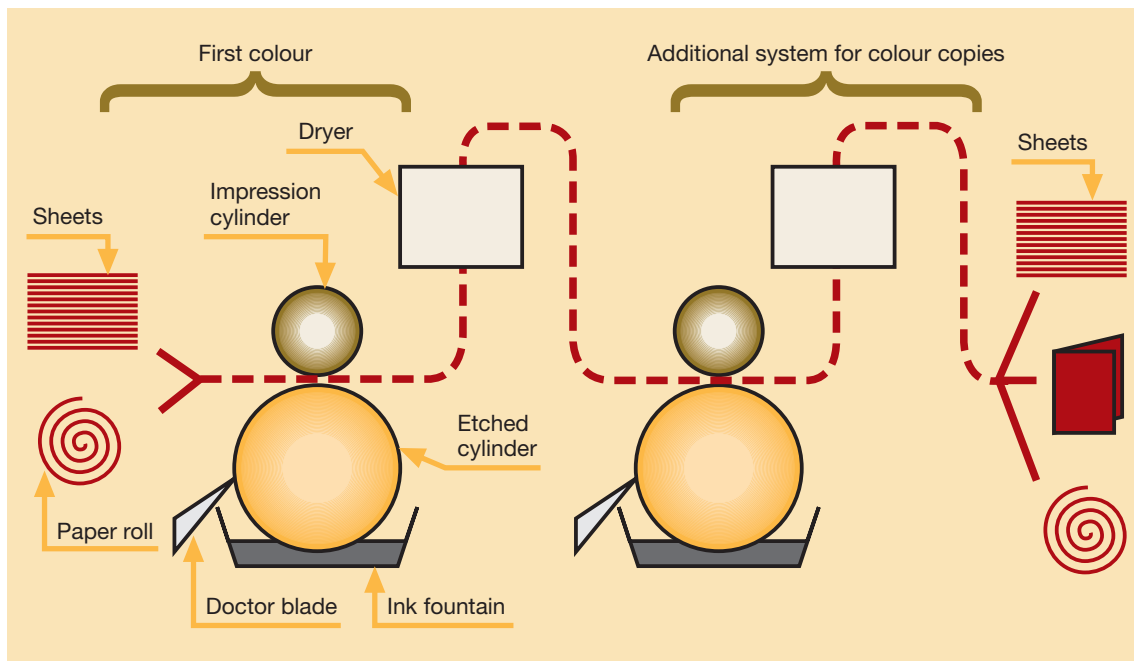

Diagram of a rotogravure system

It is a printing technique that operates with rotary presses and is characterised by its good print quality and long production runs, and is used for printing magazines, advertising material, catalogues and also for packaging, boxes and others that require the characteristics of this printing method.

4.2.5. Screen printing

Screen printing is a printing method that has the quality of selective permeability, in other words the screen printing areas are permeable to ink whereas the non-printing areas are impermeable.

The great difference between this system and the others is that in screen printing one prints on the support through the print form and not by the transfer of ink from the print form. Furthermore, the layer of ink that is spread is much thicker than with other methods, allowing for a layer that is up to 30 times thicker.

The screen acts as a selective filter so that the printing areas are open and let the ink through and it does not let the ink pass through in the non-printing areas.

Thus, the transfer of the image from the screen to the support through the fabric is done by means of a special rubber strip called a squeegee, which forces the ink through the mesh and onto the support, thus printing it.

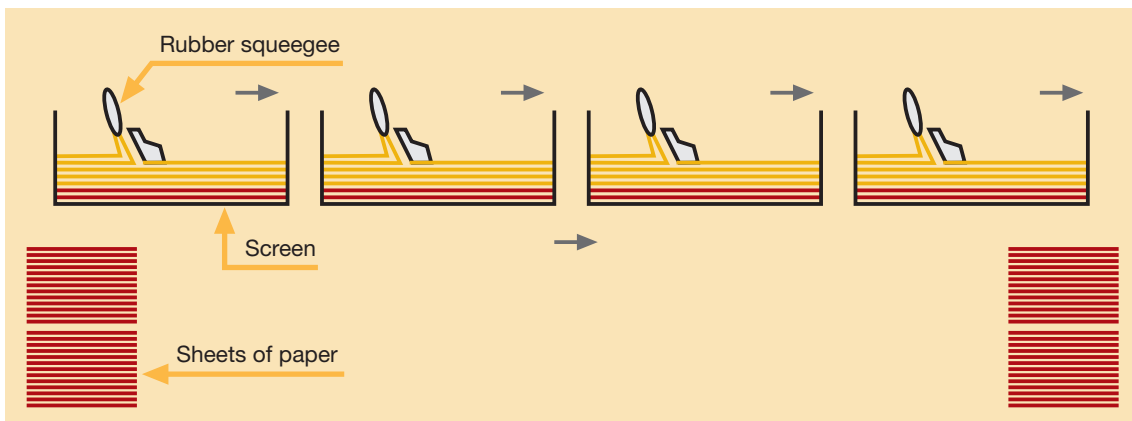
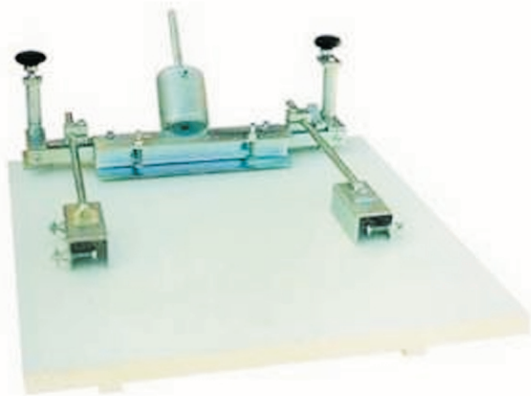

Diagram of a screen printing system



Manual printing machine



Automatic machine

The screen is attached to a mobile metal frame, so that each time a support is to be printed, the screen must be raised. When the screen is in place the support to be printed is put into place, the frame is lowered so that the support and screen enter into contact and the ink is poured on. The ink is then spread over the entire surface of the screen using the squeegee, so that the ink is pressed so that it passes through the part of the screen that has remained free of screen emulsion and impregnates the support material. Once the squeegee has been passed over the screen, the frame containing the screen is raised and the support is removed in order to pass it on to a drying tunnel. This printing process is repeated, for the same support as many times as colours are necessary.

As the ink thickness is significantly greater than in other printing systems, the drying process becomes a critical part of the process. The drying during the process may be by hot air or simple air drying (oxidation), however once the process has been finished, the finished product cannot be stacked directly, but this must be done in a way that prevents the supports coming into contact with each other, by using tables, strips of wood, etc.

It is a printing process that is generally used for short runs and special uses; it is a procedure that is varied, versatile and ductile, insofar as it is used where other printing systems cannot be applied, as is the case of printing on glass, textiles, plastics, wood, decorative materials, etc.

4.2.6. Digital printing

Is defined as non-impact printing, as there is no physical contact between the image shape and its support. This type of printing is carried out by using devices that enable the digital information to pass directly onto paper.

Digital printing is not a specific process but contemplates a series of different replicating techniques, as may be electrography, magnetography, inkjet, etc.

For example, in electrography the printing areas are marked in the print form using electrostatic charges, whereas the non-printing areas are neutral. At first sight there are no substantial differences between the two areas. This difference can be seen when the ink powder is spread over the print form and only adheres to the electrostatically charged areas, in other words, the printing areas.

As advantages of this type of printing it is worth highlighting, among others:

- No printing form or intermediate support (film) is required
- Very small print runs are feasible
- Environmental risks are avoided, as no chemicals are required for this process
- Lower cost of the manual composition tasks, the setting up of the machine, the waiting times for the drying of the ink and therefore for carrying out the post-press operations, etc.

Broadly speaking, these are methods that are constantly evolving, which constitute one of the newest and most significant advances in printing technology. It involves using an electronic printing process, to produce only the quantity the client requires, when and where needed, which opens the door to single printing tasks, pre-editing runs, etc.

In this manner, this type of printing has been widely diffused in the quick copying of documents and texts, at a lower cost than for normal printing procedures.

Having completed the description of the different types of printing, the information given is summarised in the table below, in order to show the main characteristics of the different types of printing.

PRINTING	PRINTING FORM	INK	TYPE OF PRINTING
Offset	Flat	Consistent	Indirect
Flexography	Relief	Fluid	Direct
Rotogravure	Etched	Fluid	Direct
Screen	Permeable	Consistent	Direct
Letterpress	Relief	Consistent	Direct
Non-impact (including digital)	Electric	Powder	Direct

Of the different printing technologies available that have been explained above, the offset method is the most widely used in the printing and allied industries of the world. The trend of the last few years indicates that not only will the dominance of offset printing persist but it will continue to increase. The increase in offset printing is due to a combination of good quality and low cost, as well as versatility in its supports. Essentially, it is a very practical printing system that enables high levels of quality to be achieved.

It is expected that flexography will increase significantly, and on the other hand there will be a decline in the use of gravure. From a technological point of view it is apparent that gravure continues to offer good quality, although this system is at a comparative disadvantage when short production runs or frequent changes are required, which make it necessary to make new impression cylinders every time. All this involves an increase in costs that are difficult to pass on to the client. On the other hand flexography has the advantage that it is quicker and cheaper to make the printing plates. In addition, in short runs, prices are lower and quality levels obtained from flexography printing almost reach the level of gravure printing.

The percentage use of letterpress continues to decrease, as it is being replaced by offset printing in virtually all fields. Letterpress printing is a method that is still used for short runs, above all for office material and similar applications. With reference to non-impact printing, it should be mentioned that it is a type of printing technology that is still in a state of flux and that it is expected that its evolution will lead to an increase in the trend towards the use of this technology.

Finally, a slight increase in the use of screen printing is also expected; it should be taken into consideration that packaging is becoming a product with a high market share and that a significant part of this market is in plastic, where this technique obtains excellent results.

4.3. POST-PRESS OR FINISHING

The finishing process normally includes the operations of cutting, folding, milling, gluing, sewing, making the covers, binding, and finally packaging.

It cannot therefore be considered that the printed product is finished, until it is delivered with the established format and finish of the initial design, or as required by the client.

A brief description of the most significant post-press operations is given below.

4.3.1. Binding

The objective of binding is to joint the folds or folders of a printing work in an organised fashion, in order to form a compact volume by means of a solid seam and add a strong cover to protect the book and facilitate its use.

The different types of bookbinding are normally defined by whether the pages are sewn or not, in accordance with the rigidity of the covers and its manufacturing system. Thus, one can speak of a sewn and a non-sewn binding and of paperback or hardback binding.

4.3.2. Cutting

The cutting operation is carried out in order to leave the printed product at the required size. This cutting can be carried out by using guillotines of different types: the linear guillotine, the three-sided guillotine or the shearing machine or the single-use guillotine.

4.3.3. Folding

In the folding operation the folding of a marked edge is obtained under pressure.

The necessary pressure for the folding is achieved in the manual process, with a folding machine, whereas in the mechanical process, the fold is formed between the folding cylinders; under adjustable pressure depending on the thickness of the paper.

Folding is done by different types of folding machines (folders with knives, with bags, combined, etc.), as well as different types of folding (cross folding, parallel, zigzag, folder, window, etc.).

Broadly speaking however, the folders consist of a loader (to hold the paper to feed it to the folding units), an alignment table (counter and page passage control), and the folding units (perform the folding action).

4.3.4. Gathering

Gathering is considered as the work process in which the folded signatures that make up a book are placed one beside the other, in order to form a complete block.

There are specific devices for carrying out the gathering operation, such as the gatherers and the gather-inserters.

4.3.5. Sewing

There are specific machines for carrying out the sewing operation, and they may work using iron thread or vegetable thread and they are able to use different sewing methods.

4.3.6. Milling

In general, in non-sewn binding one bases this on the principle of joining the signatures in a durable manner without using any of the types of sewing system. For this reason, they must be glued. The gluing of the signatures however, requires certain prior preparation techniques, among which is milling.

This operation consists in milling down the surface of the spine of the book, so that it is prepared for the gluing operation itself. It can be done by means of a pulse milling machine, a cutting milling machine or using a circular knife.

4.3.7. Gluing

In general, one understands as an adhesive a substance that hardens in passing from a fluid into a solid state, thus forming an adhesive film that remains adhered to the elements that have been glued together.

For the gluing operation, one can use different types of glue, as well as gluing machines, which are machines that specifically fulfil this function.

4.3.8. Stamping

This process is carried out in a specific manner by means of stamping machines, metallic coloured elements to be highlighted are added to the covers of the books or any printed part (title of the book, brand of the product, etc.).

In general, the transfer of the material is done by using pressure and heat.

5. WASTE FLOWS GENERATED

Following presentation of the raw materials and the different production processes, we will now identify the waste flows associated therewith.

The waste flows generated in the printing and allied industries are explained in detail in this chapter by means of flow charts. For a better understanding, the waste flows are separated according to their basic characteristics, in other words, to whether they are liquid, solid or gaseous emissions. For the same reason, each of these waste flows is classified according to the different printing processes, and whether these were generated during the pre-press, printing or finishing phases.

Finally, the waste flows are described in turn.

OFFSET PRINTING PROCESS DIAGRAM

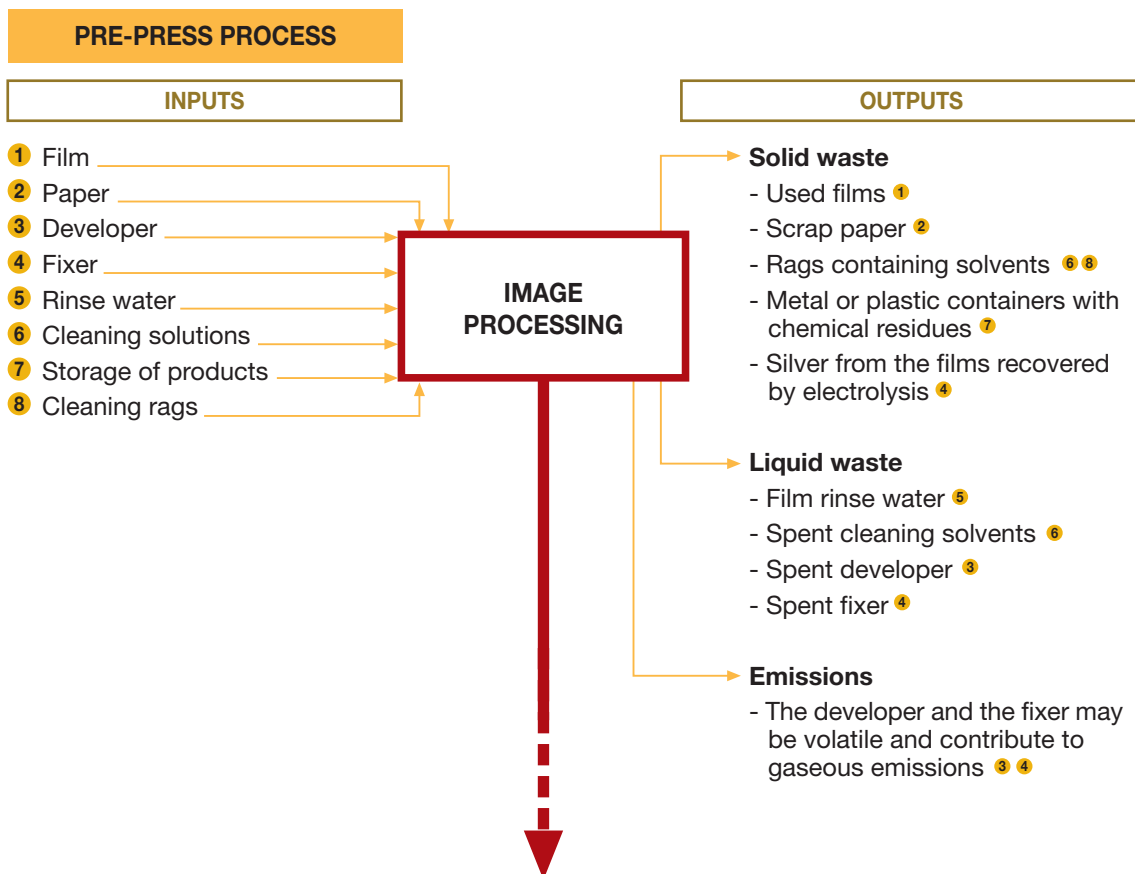

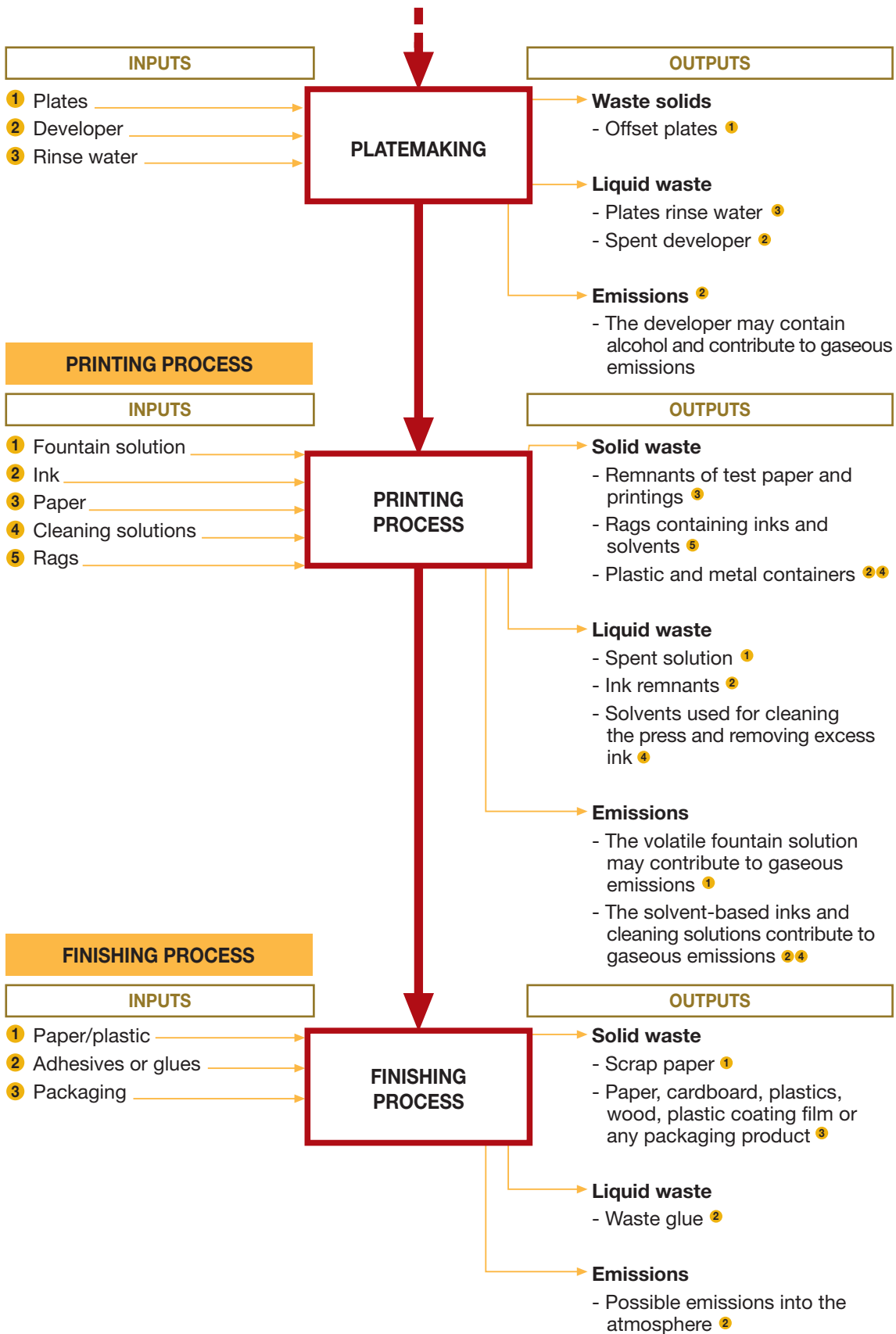
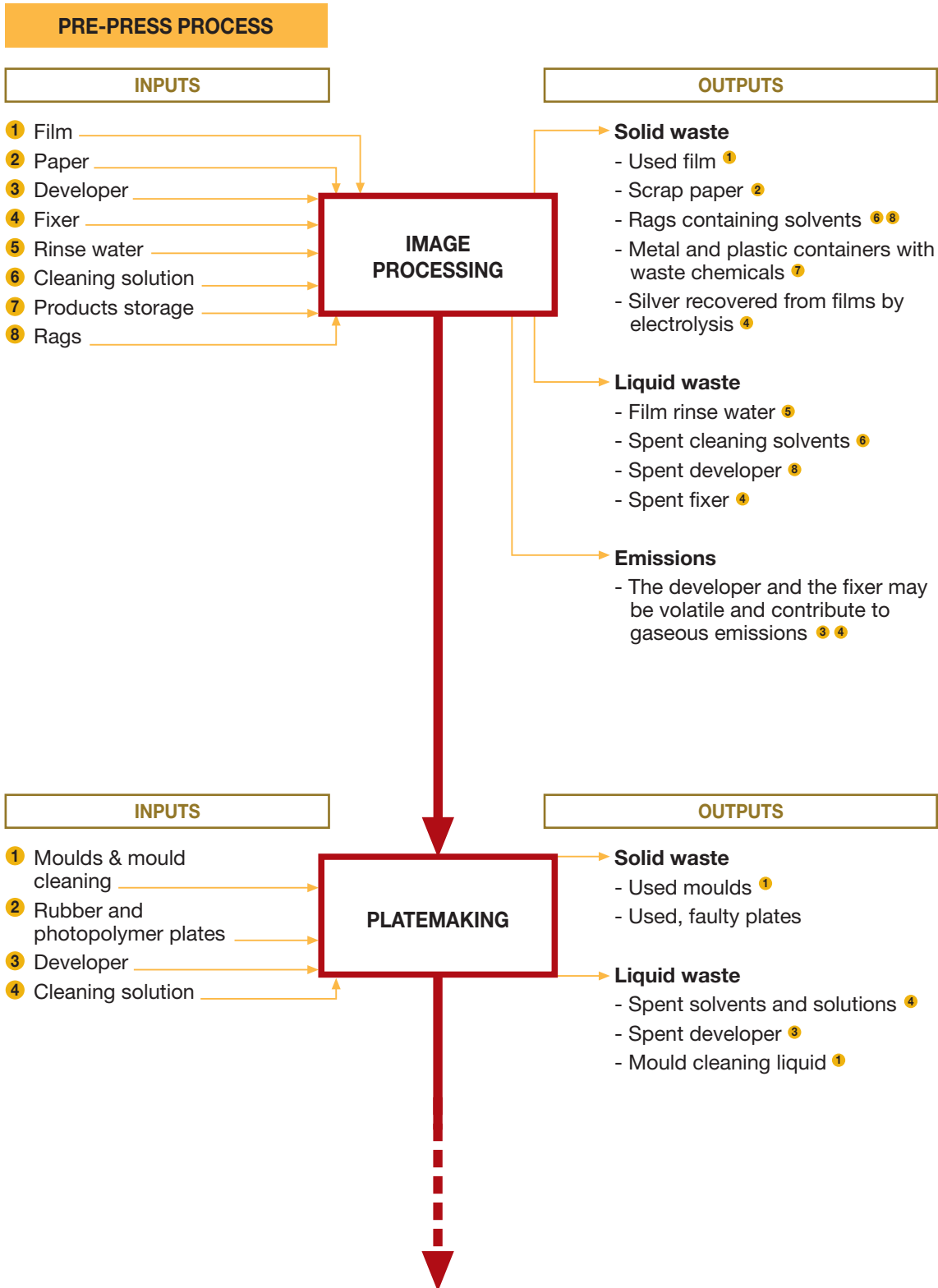

DIAGRAM OF THE FLEXOGRAPHY PRINTING PROCESS



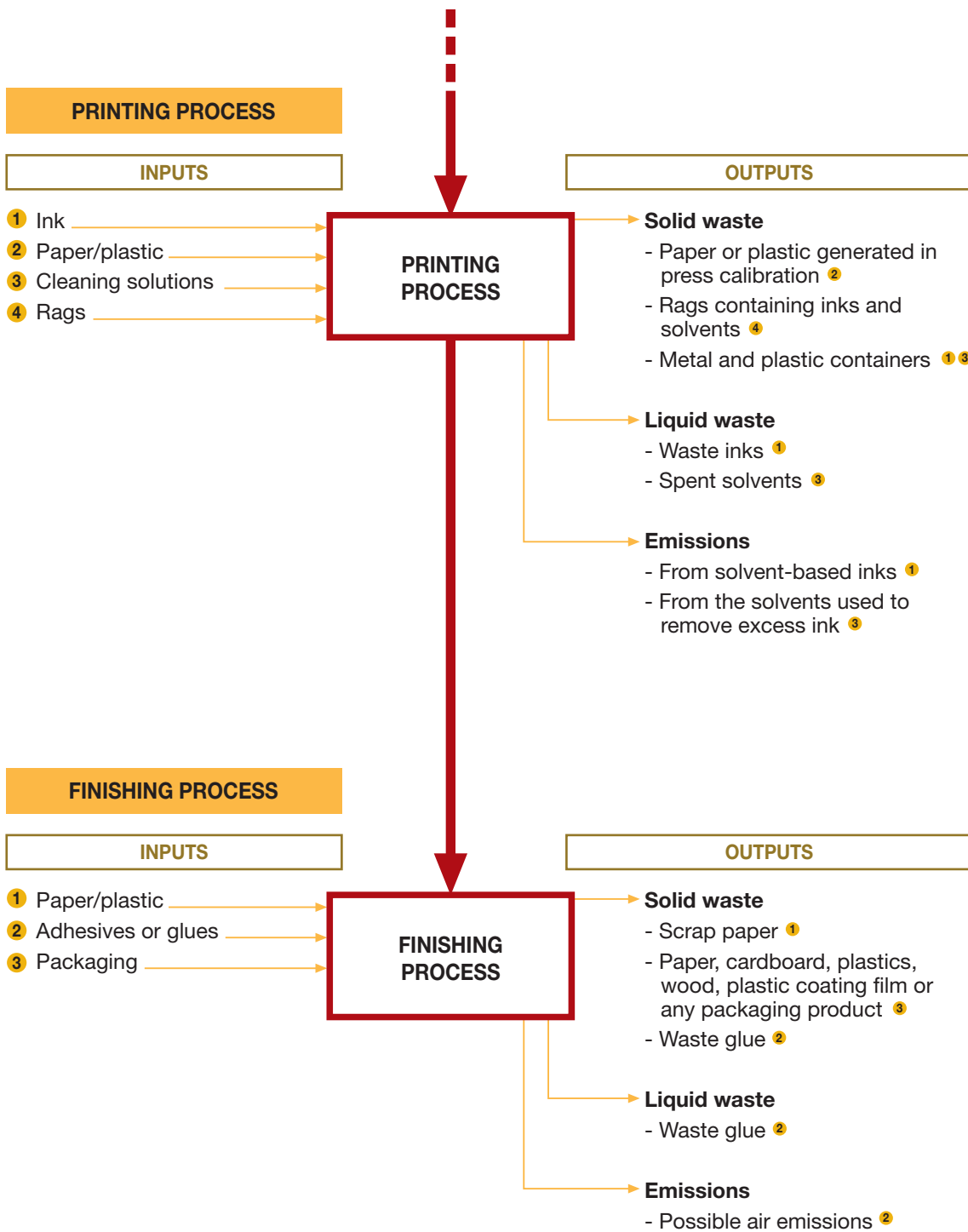
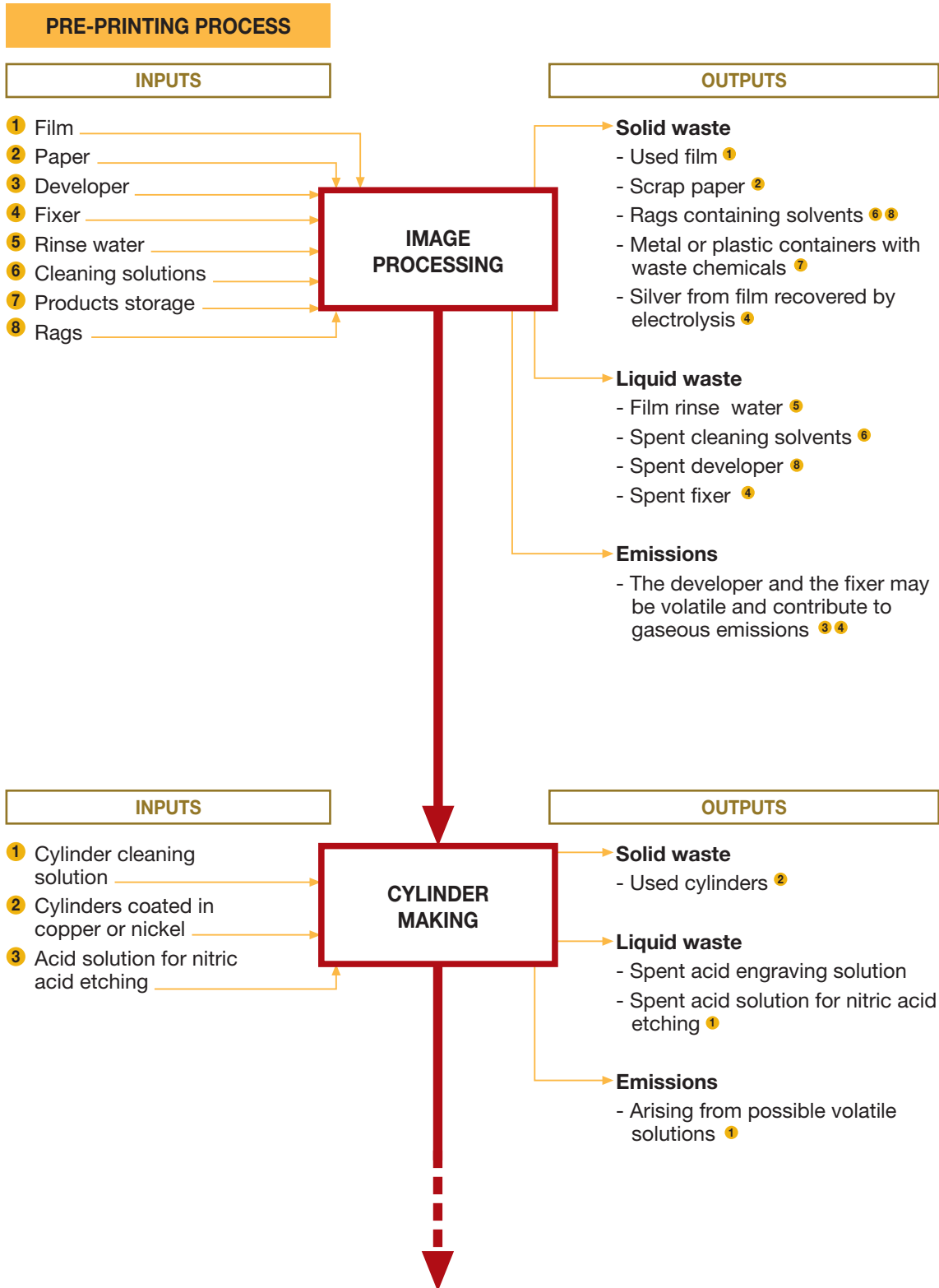

DIAGRAM OF THE ROTOGRAVURE PRINTING PROCESS



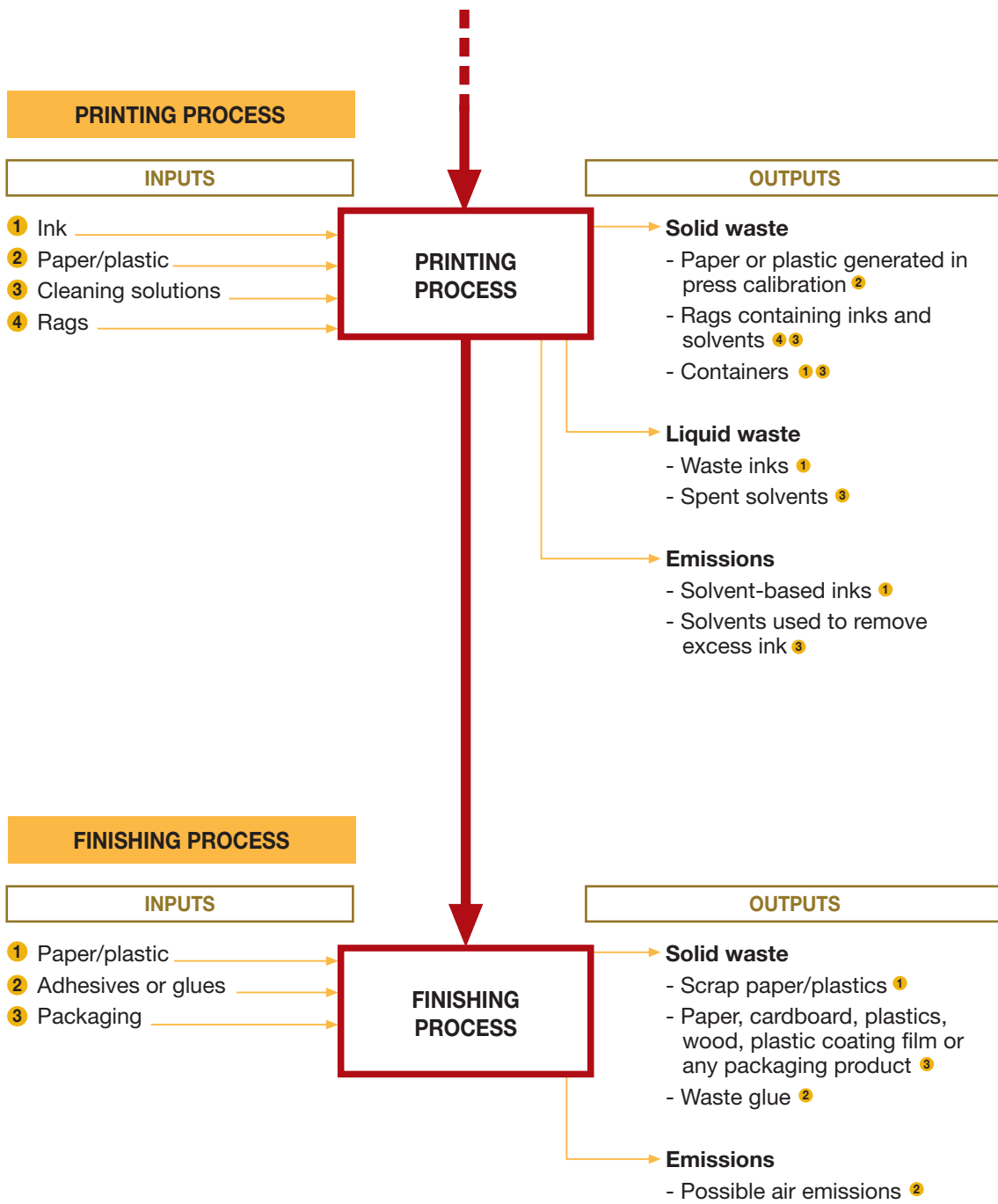

DIAGRAM OF THE SCREEN PRINTING PROCESS

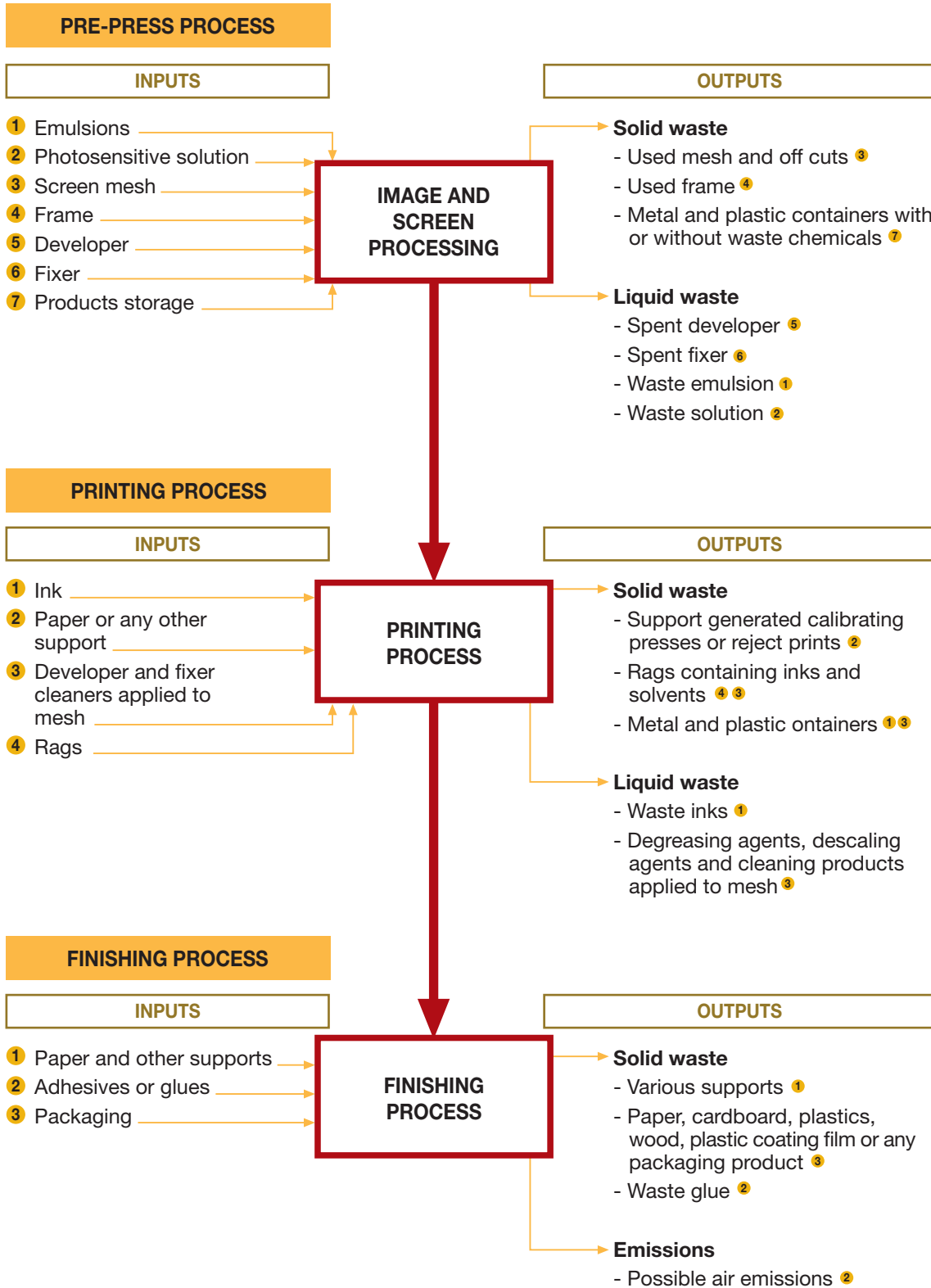
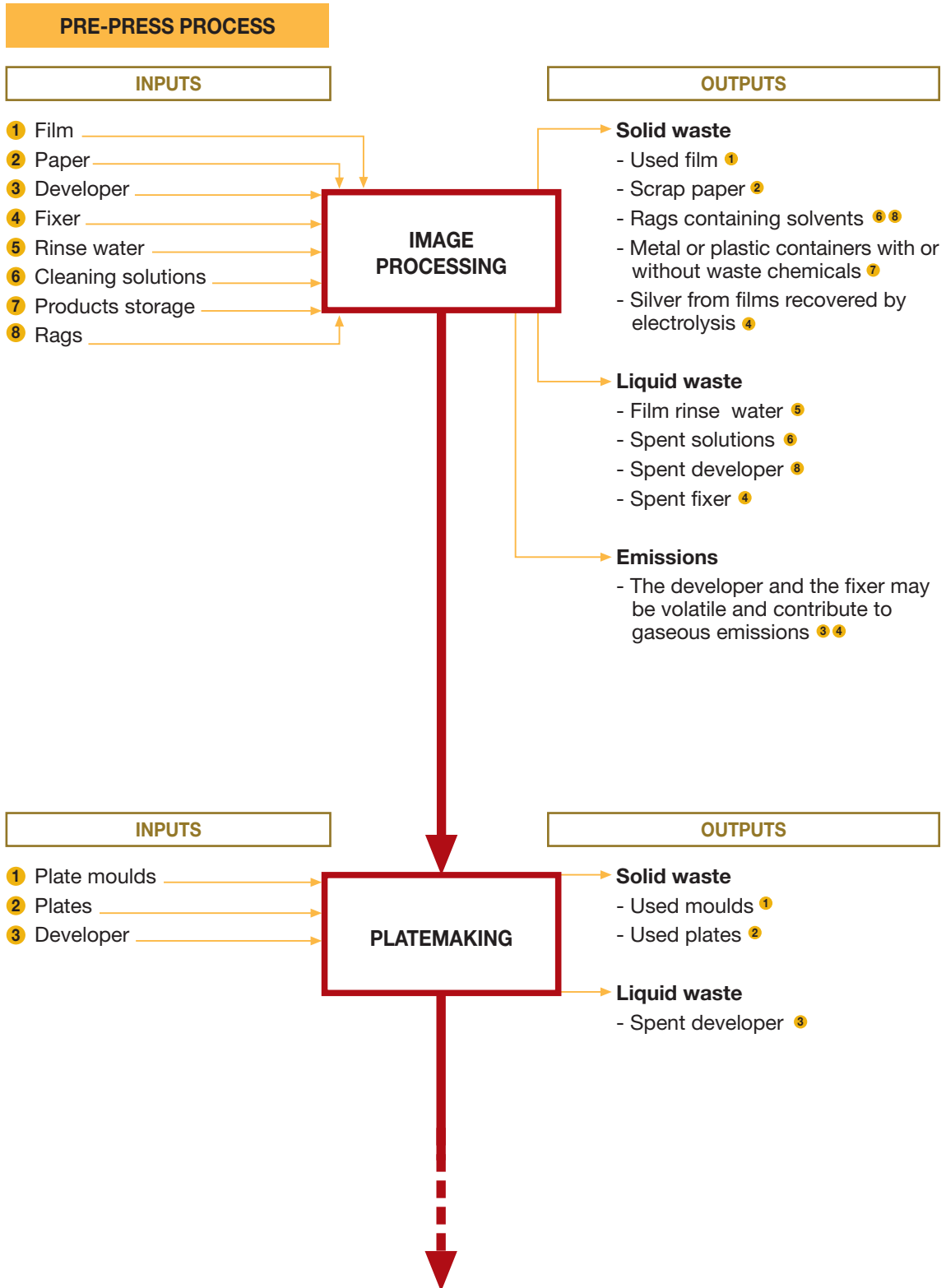
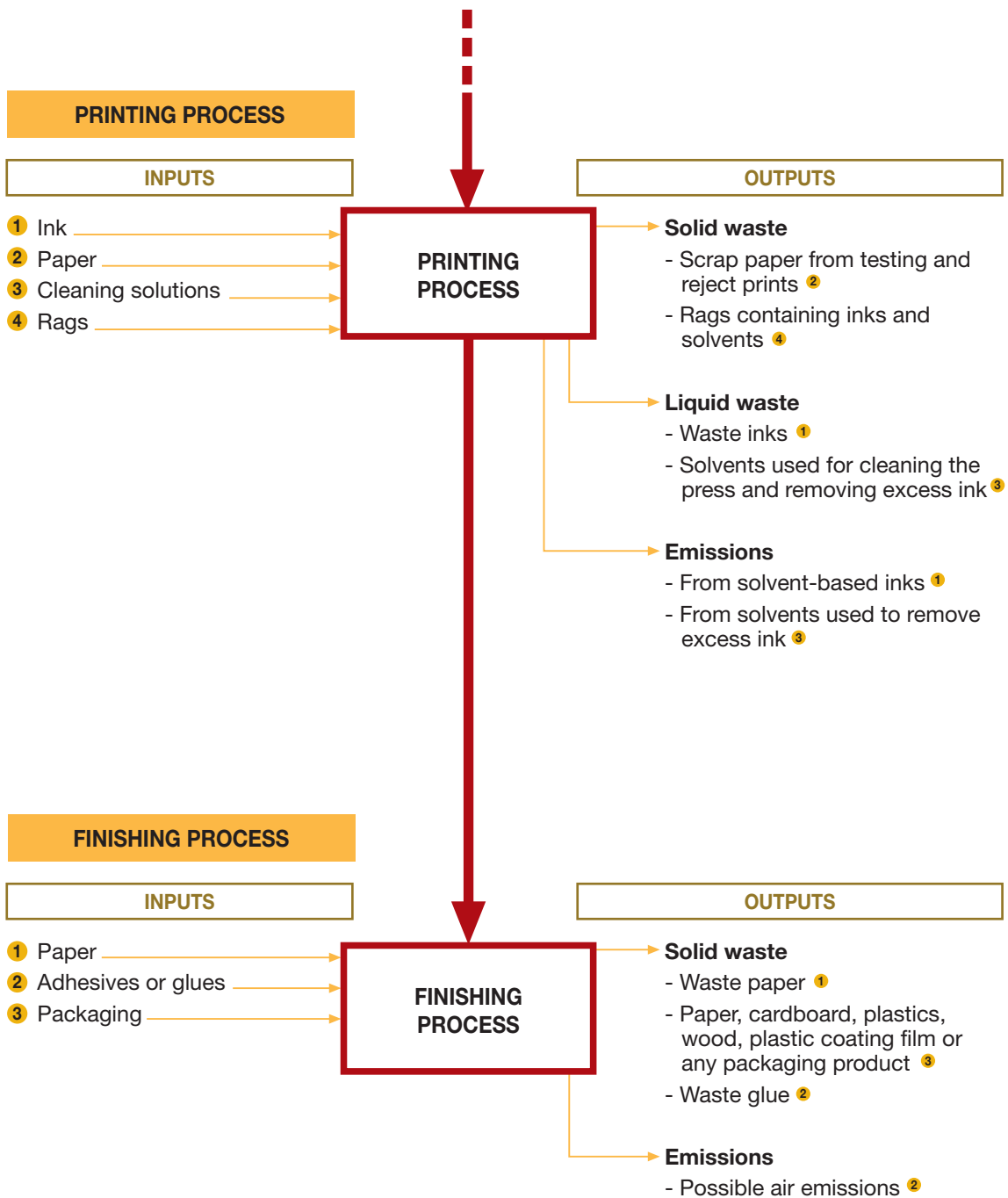

DIAGRAM OF THE LETTERPRESS PRINTING PROCESS





5.1. AIR EMISSIONS

In the above diagrams it is apparent that emissions of air pollutants occur in all stages of the printing process and with all the types of printing techniques.

Of all the emissions that occur, the most significant from a quantitative point of view, is that derived from the use of solvents in the inks, which are discharged into the atmosphere during their application and drying. This occurs most in the cases of rotogravure, flexography and screen printing.

A study has been made of the correlation factors of the production activity or stage with the quantity of ink being consumed and the emissions generated. The estimated values of the solvent emissions are shown in the following table:

BUSINESS	TECHNIQUE	EMISSION FACTOR (kg/t ink consumed)
Press	<i>Cold-set-web-offset</i>	54
Publishing/Publication	<i>Heat-set-web-offset</i>	182
	Rotogravure	145
Containers	<i>Sheet-fed-offset</i>	437
	Rotogravure	1,296
	Flexography	800
Rigid packaging	<i>Sheet-fed-offset</i>	437
	Rotogravure	1,296
	Flexography	800
Decoration	Rotogravure	1,296
	Flexography	800
	Screen printing	935
Other	Varnish	363
	Cleaning w/solvents	140

Source: Richardson, 1995; EMEP, 1996

There are other air emissions different from those occurring in the printing process. Let us see a brief description of the gas emissions generated in the printing and allied industries:

Generated in pre-press operations:

These are characterised by being emissions of little importance with regards to volume and concentration, but nevertheless they can affect the air quality in the industrial building.

- *Application of spray-on glues for the composition of the films:* emissions consisting of volatile organic compounds (VOC) and fine glue particles. Slightly toxic when inhaled, as well as irritant to the eyes and respiratory system.
- *Vapours from solvents generated in the cleaning of composition sheets:* with the same characteristics as the above.
- *Vapours from the heat-hardening of the plate:* This heat-hardening process consists in totally eliminating the solvents from the sensitive layer on plates, for which reason VOCs are generally emitted. Their characteristics are the same as mentioned in the points above.
- *Vapours generated in the ozalids:* during the preparation of the ozalid proofs, ammonia vapours are generated, as this gas is heavier than air, has a tendency to linger close to the ground, remaining in the work area.

Generated during printing:

As has already been mentioned, the most significant emissions are generated during the drying of the printed supports

- *The drying of heatset inks and varnishes:* VOC.
- *The drying of inks and varnishes UV:* ozone (quickly breaks down into oxygen).
- *Evaporation of the fountain solution:* VOC.
- *Sundry evaporations during printing process:* VOC.

Broadly speaking, and the emissions generated during the printing process are volatile organic compounds, except for the case of the inks that are dried using ultraviolet radiation.

When using UV ink, ozone is generated, this gas being formed by the effect of the ultraviolet radiation used for the drying on the air between the radiation source and the support being dried.

Generated in cleaning operations:

Some of the solvents that are normally used in the cleaning operations are: ethyl acetate, ethanol, n-propanol, isopropanol, toluene, methyl-ethyl-ketone (MEK), methyl-isobutyl-ketone (MIBK), isopropoxyethanol, cyclohexanone or xylol.

In general, they are highly volatile organic solvents, which evaporate during the different cleaning operations of the machines, largely due to lax handling of the cleaning implements: opened drums, rags containing solvents, etc.

Emission generated at other points:

Other noteworthy emissions that can be generated in the printing and allied industries, are the flue gases from the boilers in the heating system in the industrial buildings.

- *Natural gas boilers:* these basically generate carbon dioxide (CO₂), carbon monoxide (CO) and water vapour.
- *Oil boilers:* these also generate other gases, such as sulphur and nitrogen oxides.

5.2. WASTEWATER

In the printing and allied industries, the majority of liquid waste flows are generated in the pre-press and printing processes, specifically those generated in platemaking and cleaning, and the flow generated by the spent fountain solution. In this study, we have described this waste flow in the section on liquid waste. As the volumes are not very great, and due to their main characteristics and pollution potential, there is a trend in the business to collect the flow and manage it by means of authorised treatment companies. Similarly, however, there are many companies that treat these waters in their internal treatment plants.

5.3. LIQUID WASTE

As can be seen from the above diagrams, the liquid waste is generated mainly in the pre-press and printing processes. In the former the liquid waste is generated in film processing and platemaking, in other words, the developer and fixer. In the latter, the waste is generated by the cleaning solvents, ink wastes and machine oil lubricants.

Generated in pre-press operations:

The liquid waste that is generated in the pre-press operations is that from film processing and platemaking:

- *Spent chemicals from the film processor (developer and fixer):* relates to water-based solutions that become spent in film processing.

- *Rinse water from film processing*: as the work takes place in an open circuit, the quantities of water used are often quite significant. The rinsing process is carried out with ordinary tap water, however it should be taken into account that the film drags out fixer, and that therefore the water may contain residues of the chemicals used in the operation, and therefore also of waste silver.
- *Spent chemicals from the offset platemaker (developer)*: during platemaking, the developer becomes spent and must be changed. This product contains strong alkaline solutions as well as dissolved soluble substances from the sensitive coating.
- *Rinse water from offset platemaking*: produced during the plate rinsing process, it contains chemicals used and generated during developing.
- *Water from flexography or letterpress platemaking*: this is water transferred by drag-out from the non-image areas on the plate (soluble) as well as the possible solid and semisolid photopolymer wastes that are removed during processing.
- *Liquids for the preparation of screen printing screens*: as in the case above, the screens for screen printing are usually developed using water, although sometimes a solvent may be added to facilitate this operation. In this type of wastewater, apart from the presence of the non-hardened emulsion that is removed with water, one may also find the remnants of emulsion that has been hardened and rinsed off, or that may have had to be removed due to flaws in preparing the screen.

Generated during printing:

Are the wastes generated due to the use of fountain solution in offset printing and by the remnants of inks and varnishes.

- *Fountain solution*: contains waste inks and solvents, isopropyl alcohol or other substances used for reducing the surface tension of water and other products such as algacides, fungicides, etc.
- *Waste offset inks and varnishes*: in general, these are the excess and waste materials from printing runs that are emptied out of the ink fountains once the work has finished or when a colour change is required.
- *Waste flexography and rotogravure inks and varnishes*: are liquid inks with a high percentage of solvents.

- *Waste screen printing inks and varnishes:* The same can be said as in the previous case, even though the specific composition is different. These are inks that contain a greater quantity of pigments and may contain catalysts to facilitate drying.

Generated during post-press:

- *Waste glues:* although infrequent, waste may be generated from water-based and hot-melt-type glues.

Generated during cleaning and maintenance operations:

In general, these involve different types of dirty solvents, arising from the cleaning of the different machines, during both printing and post-press.

- *Offset printing:* these liquids are generated during the cleaning of ink fountain rollers, inking units and ink fountains, rubber parts, plates and doctor blades for handling the inks, etc.
- *Flexography and rotary letterpress printing:* generated in the cleaning of the ink fountains, different tanks, viscometers, etc.
- *Rotogravure printing:* generated in the cleaning of ink fountains, different tanks, viscometers, etched cylinders, etc.
- *Screen printing:* generated in screen cleaning, from squeegees, etc.
- *Gluing machines and other post-press devices:* from cleaning out glue, etc.
- *Waste oils:* generated in the maintenance process.

5.4. SOLID WASTE

Below we give a brief description of the solid wastes, although this differs from the above in not being classified by the process stage in which the waste occurs as it may be generated in different stages.

Therefore, the solid wastes generated by the printing and allied industries are:

- *Film:* is generated only in the pre-press phase, both in the filming and in the composition and decomposition procedures. Very often, these are managed together with the overall factory waste or they may otherwise be recycled to recover any possible silver content.

- *Offset plates:* may be generated both in the pre-press processes (exposure, processing and proofs) and in the printing process (used plates), both from off cuts and from faulty or old plates. Similarly, as in the case of films, these are wastes that can be recycled, to recover the aluminium they are made of.
- *Flexography or rotary letterpress plates:* these are polymer plates that are made at the same process points as the offset plates. Similarly, these wastes consist of off cuts and faulty or old plates.
- *Cleaning rags:* generated in all the business processes, basically as a consequence of cleaning operations. These involve dirty rags, usually made of paper or cotton, impregnated with solvents, inks, oils or greases.
- *Composition sheets:* as with the films these are only generated in the pre-press area, as a consequence of the composition or decomposition of the films, in the form of off cuts or old or scratched sheets.
- *Printing paper:* generally arises from storage (obsolete paper), in the printing process (macules, faulty sheets, start-up rejects and excess production run items) and in some operations that finish normally these are generated as offcuts or whole sheets, of printed or non-printed paper.
- *Plastic supports:* the same as paper, in other words, these are generated in the same areas and under the same conditions.
- *Paper and cardboard packaging:* are generated in all the business processes, basically in the form of packaging paper, protective boxes, separators, roll cores, etc.
- *Plastic packaging:* as in the previous case, the different plastic packaging materials are generated in virtually all the business processes.
- *Rubber parts:* generated in sheet form in the offset printing area, as a result of degradation as they are used.
- *Solid waste ink:* above all in the case of offset inks, which are thicker, the surplus and waste inks must be handled as for solid waste. These wastes are mainly generated in the printing area and are in the form of skins, remains in containers or particles from cleaning processes.
- *Wood:* the waste made of wood generated in all areas of the business in the form of boxes and pallets.

- *Plastic coating film*: basically generated in the finishing and packaging areas, and in the warehouses (plastic coating machine, the covering of stacks, etc.) in the form of plastic offcuts or a continuous film.
- *Toner cartridges*: these are small containers generated in the pre-press and design processes, in which it is frequently necessary to carry out tests before the product goes on to printing.
- *Sludge from liquid waste treatment*: generated as a result of the treatment of the wastes from pre-press processes, and also in the printing process and in the different cleaning operations. They are usually a paste or semi-solid.
- *Filters and filter cartridges*: businesses sometimes have filtration systems to extend the useful lives of some of the products that they use habitually. This is the case of the chemicals used for film processing and platemaking, as well as their rinse water and fountain solution. One example would be the filters in the film processors, the plate makers, the fountain solution cooling systems, as well as those of the closed oil circuit, at the end of their useful lives.
- *Metal containers of 200 or 1,000 litres*: large containers that have held solvents, inks, alcohol, fountain solution additives, water-based glues, cleaning products, etc.
- *Sundry containers*: small metal or plastic containers that have contained solvents, inks, alcohol, etc.
- *General factory waste*: general, heterogeneous wastes that are not selectively collected.
- *Sundry special wastes*: these are generally, fluorescent light tubes, batteries, various accessories, glass, tyres, cables, aerosols, laboratory samples, ammonia, various oils, etc.

5.5. ODOURS

The odours that arise are directly related to the evaporation of the products used.

5.6. NOISE

In general, the noise pollution problem in the printing and allied industries business arises from the presses and guillotines, as well as from the use of ventilation systems to collect VOCs. One should also take into account the emissions generated in the transport of both raw materials and finished products.

6. MINIMISATION AND ALTERNATIVES FOR POLLUTION PREVENTION AT SOURCE

Pollution prevention at source primarily involves avoiding its generation. Apart from the environmental improvements that are achieved, the implementation of a prevention policy has an impact in decreasing the environmental management costs, in properly defining the size in the design of waste flow treatment facilities, and in improving the company's image, providing a greater degree of protection for people and the environment.

The minimisation of waste, wastewater and air emissions is in fact the same concept as pollution prevention at source and it can be defined as a combination of reduction and recycling at source.

A proper environmental policy will only take end-of-pipe treatments and/or waste flow management into consideration, when the company has analysed and/or applied the viable minimisation options.

The following table summarises the concept of pollution prevention at source:

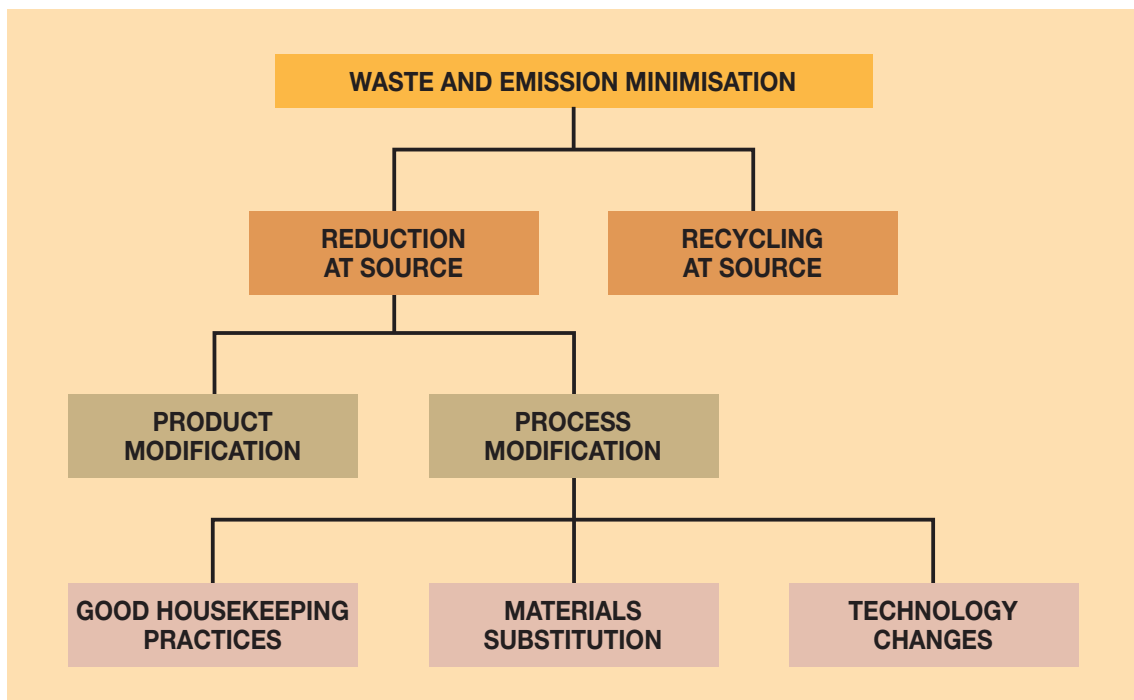

Once the waste flows generated by each of the processes in the printing and allied industries have been ascertained, the opportunities for minimising the pollution at source are analysed, so that of the section offers a series of good housekeeping practices that are more attractive alternatives than those used at present.

6.1. ALTERNATIVES FOR REDUCTION AT SOURCE

Reduction at source consists in avoiding or decreasing waste flows (or their degree of hazardousness for the environment) before they have been generated, by changing the production process, applying Good Housekeeping Practices, substituting materials and/or products or the use of technologies that are more environmentally sound:

6.1.1. The redesign of products

Product redesign is one of the options used for reducing pollution at source. The alternative proposed here can be applied to any product:

The study of the printing design:

The design stage, which is the first in the production process, is the one in which the designer, in addition to creating a product that will satisfy the needs of the client, has the opportunity to design it so that it will generate the lowest possible waste flow or that this may be less hazardous for the environment.

Product redesign enables a series of options to be studied that can contribute to reducing the waste flows, such as:

- To analyse the size of the image in order to choose the optimal paper size that will reduce scrap paper to the minimum.
- To become aware of the types of ink to be used and to use inks that do not contain heavy metals or hazardous pigments.
- To consider the possibility of reducing the quantity of ink on the support.
- To use recycled paper.

All these measures must be analysed at the design stage as they can contribute to the minimisation of the waste flows, which is the main objective of pollution prevention.

6.1.2. The redesign of processes

6.1.2.1. Raw materials substitution

The substitution of raw materials is another option for reducing the generation of waste flows. It consists in replacing the raw materials and/or auxiliary materials with others that are less toxic or that can be used in smaller amounts, although equally as effective as the former. In the printing and allied industries, as in other sectors, in some cases raw materials are used that generate hazardous wastes. Nowadays there are alternatives for some of these raw materials that are technically viable and less polluting.

Let us see some examples:

The change of cleaning solvents in offset printing:

In the cleaning process of the offset presses, the ink impregnated in the blanket, on the cylinders and on all other parts that may have been exposed to ink must be dissolved, whenever a colour change is required or the ink has dried, or if the printing does not give the desired result.

This cleaning is carried out by means of petroleum-based organic solvents. These solvents consist of a specific combination of hydrocarbon solvents, as a result of which the end product will have a vaporising pressure that will define its volatility, and therefore its potential for polluting the air. These solvents may comprise mixtures of toluene, xylene, methyl ethyl ketone, methanol and aromatic compounds, among others.

The types of solvents that will be used, depend to a great extent on the equipment to be cleaned, thus the blanket cleaner must dissolve the ink quickly and then dry immediately, whereas for the cleaning of cylinders the solvent may act more slowly. From a safety and hygiene point of view other characteristics such as flammability and odour are also important considerations.

It is necessary that, in order to work properly, the organic solvents must have a certain drying time with a precise intensity and a specific VOC content.

Once the characteristics of the solvent required to carry out the assigned work have been established, other less polluting alternative solvents may be considered, so that the release of organic compounds may be reduced.

Therefore, in order to minimise emissions during cleaning, it will be desirable to use a solvent with a low organic content, for which reason the solvent will have to be replaced with non-volatile compounds or water. Thus the following alternative cleaning products have been developed:

- 1. Water-based emulsions:** these are a combination of solvents, emulsifiers and detergents that are mixed with water in order to obtain a low VOC content. They may also contain mixtures of hydrocarbons and water, or glycol esters and solvents derived from citrus products and turpentine. The water-based products are suitable for cleaning the blankets on sheet offset machines, business rotary presses which print on supercalendered paper and for newspaper printing presses. These cleaners are rarely used for cleaning cylinders.
- 2. Vegetable ester solutions:** are derived from the fatty acids obtained from agricultural sources, mainly from soybean oil. This category includes mixtures that contain glycol ethers. The VOC content of these products goes from zero or close to zero up to any desired content; depending on the amount of volatile solvent used in their formulation, their emissions may be significantly less than those of conventional cleaners, and in addition, they are safer products as they are less flammable. Some of these cleaners are ideal for cylinders, as they perform well in in-depth cleaning operations, when a colour change is required.

They are very effective liquids, which are very easy to apply. The method for using them differs from that of standard solvents, although they are equally effective.

These products cannot be assessed from the point of view of cost effectiveness, as each company, will require very different levels of investment depending on the equipment it needs to clean and its present characteristics.

In general, the use of these alternative solvents will involve a decrease in the amount of raw material required, as these evaporate less, being less volatile. With this reduction in the emission of organic compounds into the atmosphere, a contribution is made towards protecting the environment and the health of workers.

The use of vegetable oil inks:

These inks are different from conventional oil-based inks, in that they use a vehicle that contains elements that are regenerated in nature, such as oils made from soybean, linseed, etc., although they may sometimes also contain a significant amount of petroleum-based oils in order to speed up drying. As these inks dry by absorption into the support, they are particularly suitable for printing newspaper, due to the high absorption power of the paper.

The printing quality that can be achieved with vegetable inks is better than with conventional inks in some instances, as the colours are brighter and have improved clarity.

With regard to their emissions, it should be mentioned that they minimise the VOCs and they also avoid exposing workers to mineral oils, they are therefore a more environmentally sound alternative.

Vegetable inks are characterised by working especially well with recycled paper, as they have greater stability and allow greater leeway in the water-ink balance, which implies greater flexibility in adjusting the press.

Furthermore, it is easy to remove the ink from products that are printed with soybean vegetable oil ink, making them more easily recyclable than products printed with petroleum-based inks.

In contrast, these inks are less readily available and are more costly. The drying process is also considerably slower, so that in certain cases petroleum-based oils must be added.

The equipment must be cleaned more frequently than when using solvent-based inks, so that the VOC emission problem persists.

The use of ultraviolet (UV) inks:

The use of UV inks is different from solvent-based inks in that they do not cause VOC emissions, as they contain no solvents in their formulation. These are special inks that polymerise due to the action of a photosensitive substance (a photo-initiator) which absorbs ultraviolet radiation to initiate a virtually instantaneous hardening reaction.

These inks can be applied to a wide variety of supports (plastic, paper, metal and fabric) and in different printing processes such as offset, flexography, letterpress or screen printing.

In general terms, the print quality using UV inks is comparable to that obtained using conventional inks, and when varnish is applied, the results obtained may even be better.

With no VOC emissions, UV ink offers an alternative that protects both the health of the worker and the environment. UV ink remains liquid until it is placed on the support, where it dries and solidifies almost instantly. This reduced drying time implies an improvement in productivity compared to other types of ink that require longer drying times. Moreover, the ink remains liquid in the ink fountain, with which the machines can be cleaned less frequently, and the waste flows that occur are consequently reduced.

All the ink, remains on the paper once it has been applied, so ink consumption is equal or less than that of conventional inks.

However, these are inks that contain toxins and have a higher cost, and the press operators must wear individual protection equipment (IPE) due to the UV radiations and ventilation is required in the pressroom to prevent a build-up of ozone during the drying process.

The cost effectiveness of changing the type of ink cannot be assessed beforehand as it mainly depends on the investment required and on the increase in printing capacity. The investment varies greatly and depends on the type of press and the polymerisation equipment to be installed. The increase in production capacity depends largely on the workload that the company is able to achieve.

The use of electron beam (EB) inks:

EB inks are similar to the UV inks; they do not contain organic solvents and offer the same advantages. In the EB process a high-voltage electron accelerator beams electrons through the coating, the adhesives or the inks. Photo-initiators are not required as the electrons have sufficient energy to start the solidification reaction directly.

They have the disadvantage that the press operators must wear protection against the X-rays that are generated during curing.

The use of water-based inks:

The environmental problems that arise from the solvent-based inks have led to the development of water-based inks (pigmented aqueous suspensions) which may contain from 5 to 15% organic solvents. The use of these inks enables VOC emissions into the atmosphere to be reduced considerably.

These inks may be applied to plastic supports, corrugated cardboard or paper using different printing processes, mainly flexography and also rotogravure.

Generally, when using water-based inks it is easier to achieve a more consistent colour throughout a print run than with conventional liquid ink. The colour of an ink depends largely on its viscosity, which in turn depends on the solvent content. As water evaporates more slowly than an organic solvent, the viscosity of the ink fluctuates less. This colour consistency involves a reduction in waste caused by inadequate colour hues.

With regard to the cleaning of the machines, it should be pointed out that this process is simplified, as due to the nature of the ink, it is unnecessary to use organic solvents. This implies a reduction in the cost of cleaning products and minimises VOC emissions, favouring the protection of the environment and the health of the workers.

The availability of water-based inks is still very low compared to solvent-based ones. With regard to the print quality, it should be mentioned that these are inks that provide less brightness than others, and moreover they give rise to greater abrasion and wear on the ink transfer cylinders of the press. This type of ink dries more slowly and requires an input of outside energy. This effect can be offset by reducing the thickness of the ink film, increasing its brightness and by printing on more absorbent supports.

Although the cleaning operations are simpler, significant volumes of water polluted with inks are generated, which have to be properly treated by separating out the pollutant, before discharge. Cleaning must be more frequent, as the water-based inks, become hard when dry, as opposed to the solvent-based inks that can always be dissolved again, even when they are dry.

Alternative fountain solutions combined with additives:

The fountain solution is applied to moisten the plates that use oil-based inks, in order to make them repellent to ink in the non-printing areas. One of the most common components of this solution is isopropyl alcohol (IPA), which is the main contributor to VOC emissions in offset printing.

This alcohol plays an essential role in the printing process, as it decreases the surface tension of the fountain solution, providing better moistening for the cylinder and the printing plates, and it increases its viscosity, stabilising the film that forms on the plate. Due to its volatility it also improves the water-ink ratio emulsifying less and allowing for greater water evaporation in the ink supply system, due to its volatility.

On the other hand, the use of isopropyl alcohol gives rise to a series of disadvantages. The fact that it is a highly flammable product causes storage safety problems, and moreover, in prolonged exposures, it is toxic for the workers and their working environment.

Nowadays, alternative fountain solutions are available. In some of these solutions the isopropyl alcohol has been substituted by other types of alcohol, others have merely reduced its concentration to 4-6%, and others contain no alcohol. It should however be taken into account that the alternative solution must have all the properties that satisfy the requirements of the printing technology, so that a product of a similar quality is obtained, without affecting the costs and the yield.

The application of printing technology using fountain solution with reduced alcohol implies a series of significant considerations, such as:

- The use of special wetting cylinders so that in using the new solution, the cylinders distribute the fountain solution over the printing plate in the right amount and completely evenly. Thus, although the volume of isopropyl alcohol is reduced, the water-ink balance is easily achieved.
- Working with a given alcohol concentration requires a precision measuring and dosage system with a low maximum measurement error factor.
- Measuring the conductivity in order to assess the quality and consistency of the fountain solution is essential for obtaining good printing results.
- To cool the fountain solution to a relatively low temperature, in order to slow the evaporation speed. As a guideline, reducing the temperature from 27 to 16° C reduces consumption by 40%. Thus, a temperature of 10 to 13° C is recommended for the fountain solution. It should however be taken into account that the cooling equipment must be periodically emptied and cleaned, every 15 and 60 days, respectively.
- Regulating the temperature of the inking unit enables the print run conditions to be kept constant; nevertheless, this is not essential in all cases.
- Maintaining better water quality becomes more important than with a conventional offset process, as if the water is excessively or insufficiently hard, this has a direct impact on the end result.

In order to reduce the IPA content of the fountain solution, in addition to the aforementioned considerations, the appropriate additive must be used. The additive must have humectant properties, inhibiting the growth of microorganisms and maintaining the pH level constant, as well as maintaining the chemical properties of the fountain solution. Establishing the most appropriate additive for a given printing business is a task that must be undertaken on a case-by-case basis. The different combinations tested in different printing businesses have demonstrated that the results cannot always be transferred from one to another; in other words, there is no such thing as a universal additive. By eliminating or reducing the amount of isopropyl alcohol it is possible to achieve a cost saving in the fountain solution and even a cost saving in ink, although this requires the conversion of the press for it to be able to operate under these conditions. The investment required for carrying out this conversion is varies greatly, so that it is not possible to make a generic assessment of its economic feasibility.

The use of water-based glues or glues containing less solvent:

It is possible to avoid the emission of solvent vapours by using water-based adhesives for gluing. Should this not be possible, they can also be replaced with others with a lower solvent content, such as two-component adhesives or the adhesives applied by heat, also known as hotmelt.

6.1.2.2. More environmentally sound technologies or processes

The change in technologies or processes is another of the alternatives used to reduce the generation of waste flows at source. In general, the scope of these changes can range from small changes that can be implemented in a few days at a very low cost, to the substitution of processes involving a high cost, such as changes in machinery, production sequences, automation, etc. Let us see some examples:

Programme for the reception and control of work received in computer-readable format:

This system allows for ensuring the good quality of the image before it arrives at the pre-press section, thus reducing the number of errors in subsequent stages. This reduction implies a minimisation of spoilage during production.

It consists in installing a software application that reviews the documents received from clients and is capable of detecting over 150 different potential problems in the files, simply and automatically.

In general terms, what the application does is to review the documents (created with QuarkXPress, PageMaker, Multi-Ad, Illustrator, Photoshop, FreeHand and PDF), verify all their elements, such as colours, fonts and images, and ensure that they are valid.

Following verification, it issues a report describing the problems found, thus assuring the adequacy of the information received in order to ensure the subsequent production process. The purchase cost of this type of software is between 500 and 600 euros. And therefore, if we take into account that it may save time, its cost recovery would seem to be almost immediate.

The installation of a computer-to-film (CTF) and a computer-to-plate (CTP) system:

Of the two systems the computer-to-plate (CTP) system is more developed as it involves a greater minimisation of waste flows, as in the first a film is obtained from the computer, and in the second, also directly by computerised means, the printing plate is obtained directly.

The CTP system is presently being installed throughout the printing and allied industries companies that are of a certain size, and it involves, among others, the following environmental benefits:

- The elimination or a significant reduction in the consumption of film and of all the associated chemicals used for processing, as well as of the waste flows generated.
- The elimination or a reduction in the use of the chemicals related to the processing of the plates. Even though it has not been quantified, a greater effective use of the platemaking chemicals has been detected in companies. In an extreme case, and outside the CTP system itself, a thermal system can also be adopted for plate manufacture. In this case, the use of chemicals related to the process, is entirely eliminated.
- A noteworthy decrease in the need to repeat plates and therefore of the waste generated due to this; it is calculated, based on the experience of some companies, that the volume of repeated plates can be reduced by up to 40% for those due to errors in the way they are made (exposure processes, etc.) and up to 25% for those due to content errors (motifs, texts, etc.).
- The suppression of errors in the traditional manual composition operations, and in the plate making phase, as one passes directly from the pre-imposed digital material onto the imposition plate.

The installation of a CTP system implies a significant change in the company, both in its premises and also in job creation. Nevertheless, it should be taken into account that the installation of the CTP system does not mean the old system can be abandoned completely, as this does not strictly depend on the company. It depends largely on whether the clients can deliver the work they require in computerised format.

As can be seen from the example explained in the previous chapter, the cost effectiveness of installing a CTP system depends on receiving large orders.

The use of waterless offset printing systems:

This is a process under development that can be applied in an offset system, eliminating the fountain solution or system. The system requires:

- The use of a printing plate coated in silicon, which substitutes the water-based medium. Under the layer of silicon there is a special photopolymer that is receptive to the inks.
- The need to reformulate the inks, as, there being no water present, the temperature of the system increases and the rheological properties of the inks change.
- The redesign of the presses, eliminating the ink fountain system and adding a temperature control system.

The environmental benefits that are obtained from introducing of alternative consist on the one hand in eliminating the fountain solution and all the chemicals it contains (acids, bactericides, fungicides, IPA, etc) and therefore the waste flows generated by its exhaustion, and on the other in eliminating VOC emissions.

The absence of water in this system favours the minimisation of the print rejects that arise when obtaining the water-ink balance in conventional systems. It also gives a brighter and more consistent colour that is maintained stable during the entire print run. Moreover, the starting up of the printing is quicker and the preparation time of the industrial process is therefore shortened.

Minimisation in the fountain solution consumption in offset machines:

Generally, the fountain solution that is used during the offset printing process is re-circulated until it is so deteriorated it has to be changed, thus visibly affecting the quality of the printed work.

The reason for the deterioration of the fountain solution is its contamination by paper and ink wastes, which it picks up during the printing process, changing its conductivity levels, until it needs to be changed.

Nowadays there are filters specially designed to improve the treatment of the solution. Using them means the fountain solution can be changed less frequently and thus extends its useful life, minimising the amount of waste liquid generated in the process. This filtration leads to a decrease in the incrustations in the machinery and consequently a reduction in the related cleaning maintenance of the tanks and pipes. The proper filtering of the fountain solution also improves the conductivity stability, eliminating marks and reducing the greasing of the printing plate.

In order to achieve these benefits, filters should be introduced along with certain working conditions. An appropriate temperature of the solution and regular changes allowing for optimal working conditions, can lead to a 50% saving in the volume of fountain solution used, and therefore an identical decrease in the amount of treatment required for wastewaters. The installation of this filtration system is highly recommended as it simply involves a filter cartridge that is inserted in the cooling device at the inlet of the re-circulated solution.

These filters cost about 700 euros each and they last from one to two months. So the annual cost may be around 8,400 euros. The payback period depends on the amount of solution used. With the reduction in consumption of the solution an annual saving of 50% can be achieved and consequently a 50% reduction in the cost of treating the waste solution.

Elimination of isopropyl alcohol from the fountain solution:

There are certain technologies on the market that contribute towards achieving the necessary properties for offset printing without using alcohol, such as those described below:

- **State-of-the-art fountain system:** by means of an automatic fountain solution system, a constant thin film of water can be maintained on the surface of the printing plate.

This thin film, that is required to achieve constant quality during the printing process, is obtained by the pressure applied between two cylinders (the blanket and the distributor), which in turn have oil affinity and water affinity. Between them they create a water-ink emulsion that is distributed by the blanket cylinder onto the surface of the plate, where its natural selectivity determines whether it picks up water or ink. The excess is collected by the blanket cylinder itself, and it returns it to the fountain solution store formed by the contact line between the fountain cylinder and the distribution cylinder.

An oscillator regulates the water-ink distribution and it is only necessary to adjust the inking unit based on the image. The cylinders have a certain specific hardness and finish, in order to ensure a precise, even and constant film of the water-ink emulsion on the plate.

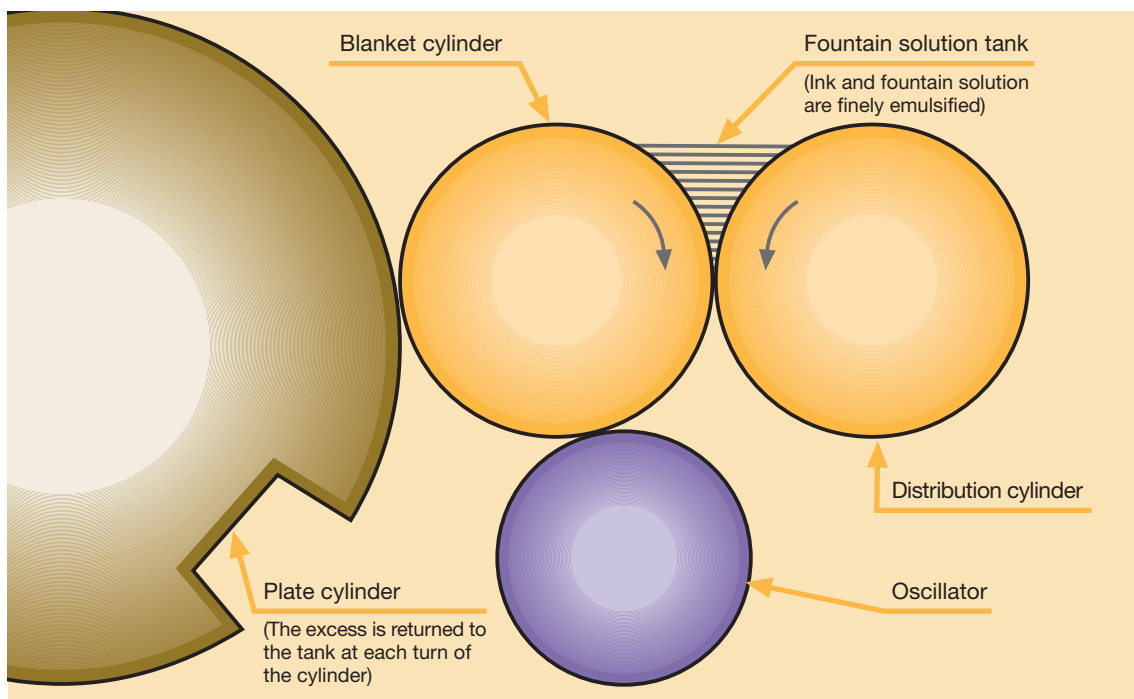

Automatic fountain system diagram

The use of these fountain systems is well tried and tested, although the installation should have a solution with appropriate temperature, conductivity and additives.

Thus, this fountain system achieves a saving with minimum consumption of ink and water, the elimination of isopropyl alcohol and a decrease in print rejects at set-up time. The cost of the fountain system ranges from 3,000 to 20,000 euros per colour and depends on the type of press. The investment required to undertake this conversion varies greatly, so a generic assessment of its commercial viability cannot be made.

- **Water oxygenation:** this technique consists in injecting oxygen into the fountain solution so that the water attains a degree of O₂ absorption on the plate so that the water-ink interface tension is equal or less than that of water-alcohol, and the film is sufficiently fine so that it does not cause excessive emulsification. This injection of oxygen eliminates the isopropyl alcohol; it is however necessary to add another specific additive that has been officially certified by the Fogra Institute that does not contain any primary or secondary alcohol and that is used to maintain the pH values under control. In this way a fountain solution is achieved that offers greater uniformity of the ink over the plate as well as a finer and more homogeneous film. In addition, this technology achieves improved transfer and drying of the ink. Furthermore, this technique yields brighter colours on the printed support, an ink saving of up to 14% and better printing quality than that obtained using fountain solution with isopropyl alcohol.

The equipment capable of supplying the cylinders with this fountain solution for a press with 4-6 colours and without cooling equipment has a cost of around 12,000 euros. In any event, the cost saving achieved depends on the cost of the new additives and the quantity of ink used with the new solution.

Colour measurement installations:

Although colour control may often merely be by a visual check throughout the print run, it is very important to have an objective analysis by means of devices that read the colour in a manner that ensures that it is truly correct. In addition, it should be taken into account that the fact that the devices used for measuring it enable colour variations to be detected throughout the print run, before this can be done by the human eye, so that there is less spoilage than if the measurement is carried out visually. Densitometers, colorimeters or spectrodensitometers are used to take these measurements.

While the densitometer measures the amount of light reflected by an image and the colour is controlled by comparison with colour control strips, the colorimeter is an instrument for measuring and identifying the colour in absolute terms, not comparatively, by the reflection from the original. Finally, the spectrodensitometer measures the density, the percentage dot on special inks, and the relative printing contrast.

In order to carry out the colour measurements correctly and so that these may be standard, they must be done at a light temperature of 5,000° K. Standardised desks or light cabins that use this type of lighting can be used to take the readings, so that when the colour has to be checked, a reading has to be made, etc., the printed material is taken to the desk and the operation is carried out.

The costs of these devices are approximately as follows:

Densitometer:	500 euros
Colorimeter:	275 euros
Spectrodensitometer:	450 euros

The cost effectiveness of these devices can only be assessed after the fact, as the savings that can be achieved for each company are very different.

Optimisation of the automatic solvent addition system for rotogravure and flexography printing machines:

The flexography and rotogravure machines work using liquid inks that sometimes have a very high solvent high. Often the ink fountains and the ink pans on the machines are left open, allowing the evaporation of the solvents in the inks, to the extent that these may become excessively viscous. It should be remembered that the variation in viscosity involves a variation in the colour hue of the end product.

This makes it necessary to adjust the viscosity indices of the inks throughout the printing process on an ongoing basis, which is often done manually by pouring solvent into the ink fountains of the printing presses that are left open during the printing process.

At this point automatic systems can be installed that add the solvents to the inks, so that the degree of viscosity is maintained and the surface of the solvent in contact with the air, and therefore its evaporation, is minimised.

As a general description, these systems comprise a pump that takes up the solvent from a tank and pumps it into the ink fountain, a monitoring system with a counter that enables the volume of solvent pumped to be known and adjusted, and an electrovalve that opens and closes the flow of solvent into the ink fountain.

This system offers two options: a simple system which is similar to a drip feed mechanism, which consists in adding the solvent at a certain adjustable rate at a specific constant volume,

and another in which, in addition, the control mechanisms have a viscosity meter to measure the viscosity of the ink, and based on the value of this parameter, to add the required amount of solvent.

This control reduces ink consumption, since while the automatic addition maintains the viscosity constant and therefore the desired hue, and visual checks monitor the resulting colour hue once the printing work is at the end of the run. This implies that the press operator, in order to avoid rejects due to sub-standard printing colour hue quality, will always try to give a somewhat excessive colour hue.

Another parameter that must be controlled is the temperature of the inks. As a consequence of the heat generated by the press and the printing process itself, the temperature of the ink rises. This increase forces the printer to add solvents more frequently and in greater quantities, so that it becomes harder to control the viscosity. In order to avoid this undesirable effect, it is possible to install an ink cooling system.

Thus the control of the viscosity and temperature of the printing inks leads to improved quality of the printed work as precise hues are guaranteed during printing. This reduces both faulty printing rejects and solvent consumption while VOC emissions decrease, due to lower evaporation. It is a very simple installation that gives good results. Its economic feasibility is explained in the following chapter.

The installation of closed-chamber ink fountains on flexography machines:

There are closed-chamber ink fountains on the market for flexography machines that provide benefits, not only in reduced evaporation, but above all in the improved quality of the printed work and in the productivity of the printing machines.

Broadly speaking, an ink fountain of this type comprises two chambers, one that applies the ink and one that removes it, installed directly on the anilox roll. During operation, the ink is applied at low pressure and in a controlled manner onto the cylinder, and then by pressure from the supply chamber, it is forced to penetrate the cells, while the excess is drawn off into the outlet chamber.

This system has numerous advantages. Firstly, the decrease in evaporation leads to a healthier environment for the workers and a decrease in air pollution. Secondly, it ensures an even transfer of the ink over the entire printing surface (also during changes in speed), and an equal or better level of colour grammage. Similarly, the reduced and controlled transfer of the ink makes for shorter drying times, a fact that implies an increase in the printing speed and therefore in productivity. Thanks to its stability, the system allows for soft and very light pressure on the contact points between the plate cylinder and the impression cylinder and

the anilox roll. Thus, not only are there fewer rejects caused by non-printing cells, but also printing plates are obtained that offer cleaner clear areas and less build-up of ink in the cells.

There is a combined system for very quick cleaning of the entire printing system, which substantially reduces the changeover time. Although productivity increases of up to 9% can be achieved, its commercial viability depends to a great extent on the capital investment required to carry out the change. As it is a system that requires making significant changes to the existing machines, the investment can be quite considerable and will vary depending on the type of press. It is therefore advisable to introduce this system on large machines with four or six colours, and with high workloads.

Dispensing system for ink dosage:

In the printing and allied industries, manual operations for supplying inks to the presses or making mixtures in order to obtain the desired colour are normal practice. These operations are a source of errors, spillage, excessive cleaning and significant solvent emissions. Nowadays it is possible to install an automated ink dosage system, to give the desired amount of ink and colour as long as the mother tanks contain a sufficient volume and the basic inks.

The automation of the ink formulation system requires control and colour formulation software, a set of mother tanks with the necessary components and a suitable system to supply the components so that the colour formulation can be obtained with the required degree of precision. This system, known as the dispensing system, can be installed for offset printing, flexography, rotogravure or screen printing, although to be cost-effective, it requires high ink consumption.

The dispensing system, apart from facilitating operations, reduces the quantity of waste inks caused by human error in weighing or in accidental leaks in the transfers. It also entails a significant reduction in the warehousing space required, as the ink tanks are of 500 litres or more, instead of 25, 10 or even smaller, which is the capacity of the containers that are normally used, and in addition it is not necessary to have one tank per colour as the colours are obtained by combining the stored colours. Whereas with the conventional system a great number of empty containers with ink wastes are generated, with the Dispensing system apart from the containers being bigger, it is generally the ink manufacturer that collects and reuses them.

Finally, two great advantages of the Dispensing system should be highlighted, the first is that VOC emissions can be avoided during preparation, as the supply system is hermetic, and the second is that the system is capable of reformulating inks from surplus inks, for which reason these are recovered. As can be understood from the example explained in the previous chapter, the commercial viability of installing an ink dispensing system depends largely on the ink savings that are achieved.

Systems for cleaning implements with ink residues:

During the various handling phases in the different production processes in the printing and allied industries, both the machine and the implements used to supply the inks become dirty and require cleaning.

A certain type of solvent is used for cleaning depending on the ink used. This liquid must dissolve the ink impregnated in the object to be cleaned.

Once the solvent has been ascertained, the cleaning method must be defined, and whereas some parts must necessarily be cleaned manually on site, there are others that are not fixed, which can be put into cleaning machines specifically designed for this purpose. Let us see some examples:

- Thus, for example, cleaning them can minimise the volume of ink containers to be managed as a waste. In this way, there are no dirty cans to manage; they can be reused, or even subsequently recovered as scrap and as plastic.

With reference to this device, it is a machine that is specially designed to clean ink cans, which are handled manually, one by one. It consists of two standardised, airtight elements, which hold the can to be cleaned at a 45° angle.

Once the can has been inserted into the cabinet and by rinsing and scrubbing with a brush, it is cleaned in a few seconds using the solvent from the tank of the cleaning machine itself, which makes it possible to carry out a subsequent rinse in a second process.

It is a totally independent machine which is very simple to operate and easy to install. It is specially designed for small containers and its cost varies between 6,000 and 9,000 euros.

The cost effectiveness of installing a cleaning machine must be studied on a case by case basis, as it depends on the number of containers, and the staff and time available to carry out this cleaning and of the savings generated by its subsequent management.

It should be taken into account that depending on the time required by the cleaning staff, the speed with which the container is cleaned before the ink dries and the quality of the cleaning attained, adequate levels of cleaning can be achieved for the company to recover the containers easily. If the cleaning is inadequate, its management will only involve a reduction in the cost.

- Another example of cleaning is that of the blades for handling oil-based inks in offset printing. The function of these blades is that of picking up the ink, mixing it, putting it into the ink fountains, etc. Normally a blade is available for each colour, and above all in companies that work with many special colours, the need to clean these blades becomes extremely important.

These blades are cleaned by rubbing them with rags soaked in solvent, for which reason a significant quantity of these dirty rags is generated. In order to minimise this waste flow a small blade cleaning device can be installed.

These devices work using a series of brushes which scrub the blades using a solvent that is re-circulated for successive cleaning tasks, so that the amount of waste generated by its use is minimal.

The installation of this small device is very simple and causes no operating problems. Its cost effectiveness is analysed in the next chapter.

- There are also cleaning tunnels or automatic cleaning chambers where the ink fountains and other parts of the printing machines are manually placed on mechanical guides that move the part to ensure more efficient cleaning. Once inserted, the parts are cleaned using the appropriate vaporised solvent spray, in order to dissolve the impregnated ink until they are clean.

In addition, the cleaning tunnel has a gas recovery system above it and a cooling tower where the vapours generated during the cleaning process are condensed. The dirty solvent is pumped directly into the distiller, where it is recovered to be used for cleaning once again.

The cleaning of the different materials in the automatic cleaners not only minimises the consumption of organic solvents, due to their subsequent recovery, but it also minimises the concentration of VOCs in the atmosphere as it cleans by using closed chambers.

6.1.2.3. Good housekeeping practices

In addition to the waste flow reduction solutions explained in this chapter, there are a set of personal and group habits that ensure that each person in an organisation will adhere to proper environmental management procedures, which minimise the impact of our industrial activity. The implementation of Good Housekeeping Practices ensures a series of benefits such as a cost saving due to the rationalisation of the use of certain resources (water, raw material wastage, etc.) and the minimisation of waste flows. In most cases, Good Environment Practices can be implemented with very little cost, and they therefore have a quick return on investment. Let us see some examples:

Good housekeeping practices in the pre-printing process:

In the processes for manually developing film, the useful life of the chemicals used depends largely on the time they are used and their direct exposure to air (oxidation of the developer). To reduce contact with the air, a floating plastic cover can be used same size as the inside of the developer bath. This can extend the useful life of the developer by up to 50%.

Quality control of the production processes to minimise losses during printing:

The minimisation of losses that occur throughout the production process can lead to a significant savings. This saving can be achieved in three ways:

- The minimisation of the quantities of raw materials used.
- The minimisation of the quantity of end waste generated, and therefore of the need for its subsequent treatment.
- Improvement in the performance of the printing machines.

In fact, even though spoilage is not one of the most troublesome waste flows in production from the point of view of a pollution risk, they are one of the most costly for the company (if one takes their management cost into account, the lost production time, the costs of the errors, etc.).

In this sense, several solutions are suggested, all of them closely related to production control and process quality, as basically, and with regard to these wastes, their minimisation necessarily involves an improvement in the production processes. Let us see some examples:

Control scales in the preparation of offset plates:

The control scales are used for verifying the quality of the plates in order to detect flaws, or the fact that they may not have been properly prepared. In this sense, and as it is usual to work using traditional methods in the printing and allied industries, these plates are prepared solely relying on the experience of the craftsman, without using objective control measures for quality assurance. The verification of the correct preparation of the plates can be carried out by taking periodic measurements using the UGRA and KKS scales.

The UGRA control scale is used for controlling the dots on the plate, an aspect that is closely linked to the control of its correct exposure. Similarly, the percentage loss can be established with respect to the starting point during the exposure process and assures a specific level of sharpness on the plate. This scale is a film with different control images (continuous colour hue scales, micro-lined images, etc.). In its normal operation, the scale is placed on top of the plate and different exposures are made until the exposure level that is considered as the correct one is reached. Although it may often be considered that it is easy to ascertain this level, in practice problems often arise with respect to the type of plate being used, as well as with the state of maintenance of the exposure lamp.

In contrast, the KKS scale enables us to ascertain whether the vacuum level reached in the frame of the exposure unit is appropriate. In this case, the scale has three points of a specific thickness, surrounded by a measuring scale. In its normal use, it is placed on top of the plate during exposure, and based on the vacuum level created in the frame of the exposure unit; the scale shows a higher or lower exposure level.

Using these controls reduces the levels of waste due to faulty plates and prevents the starting of print runs using plates of inferior quality. These strips should be protected and handled with great care, and they must be changed when they become old. The cost is about 100 € for each KKS strip and about 175 € for the UGRA scale strips. Taking into account the time and production waste savings involved, their cost effectiveness is assured.

Lighting in the area for preparing offset plates and screens for screen printing:

Often, in order to make offset plates, and above all to make screen printing screens, photosensitive emulsions are used that harden when exposed to light. It is important to illuminate these areas with yellow light, so that even if it shines on the emulsions, this does not lead to unnecessary hardening.

It should be taken into account that if white or blue light shines on the emulsions once these have been applied, unnecessary hardening may occur, which requires corrections to be made on plates or screens to be redone and if the plates fail the quality control before going on to the press, this may even lead to stopping the print run in order to carry out the corresponding corrections or reruns.

Logically, when this situation occurs it causes a loss in materials and production time, which must be avoided.

Improvement of the Pantone charts and the colour control strips:

Reference colour samples are used in many companies in order to adjust or verify that the printed colour is adequate. The verification is carried out by comparison, either visually or by means of a device that measures the colour. The Pantone charts, which can be considered as a catalogue containing all the special colours, are used for verifying the colours and are a reference for adjusting the colour at the beginning of a print run. In other words, when the print run is started the colour is adjusted in accordance with the colour on the card until it matches, and then the print run is started. From then on, the colour adjustment throughout the print run is made by comparing it with the first sheet, which becomes the reference sheet.

It is therefore necessary to properly maintain the colour guide, as if the colour of the first sheet, which acts as a reference, does not have the proper colour, this would lead to unwanted rejects. Similarly, the colour control strips are used for ongoing testing and adjustment of

the colour if necessary, throughout the print run. It is therefore also necessary to keep these strips well maintained, as they gradually deteriorate with use and exposure to ambient light. Obviously, when the colour reference samples are worn they should be replaced with new ones. This occurs fairly regularly. The cost of the Pantone guides is approximately 120 € and they last for two years. The colour control strips cost approximately 200 € and last six months.

Finally, it should be added that tools that reduce spoilage and therefore duplicate run times, also entail a cost saving.

Conductivity measurement of the fountain solution in offset printing:

In the offset printing process, one of the critical points is the fountain solution, as to a great extent the final quality of the printed work will depend on its good state and effectiveness. In order to control the state of the solution throughout a print run, and apart from carrying out a visual check that may detect decreased quality at any given time, a conductivity meter is required in order to measure its conductivity on a regular basis. This measurement helps to monitor the quality and the consistency of the fountain solution. For example, if its conductivity increases this may imply the solution is very dirty and that its physical and chemical properties have changed as it contains other substances. Thus, if this variation is greater than 600 mW it is advisable to change or regenerate the solution, as degraded solution affects the printing quality. The installation of this device may prevent spoilage caused by degraded fountain solution.

The cost of this device is around 600 €, and in addition it monitors the temperature and pH of the solution. The cost effectiveness of this device can only be ascertained after it has been installed, as the savings achieved vary from company to company.

Preparing the support prior to printing:

Generally, the printing support is kept in warehouses until it is used, and then it is transferred to the pressroom. There is normally a difference between the moisture and temperature of the storage area and the pressroom. This circumstance can easily cause changes in the support (basically paper, cardboard or similar products) such as contraction or expansion during the printing process, so that there are movements in the register that give rise to a faulty product that must be withdrawn. This type of spoilage is avoidable if before printing, the support is allowed to adjust to the temperature and moisture parameters.

In this sense, it is worth taking a couple of aspects into account:

- If the support is left wrapped up at all times in storage and is only unwrapped when it is going to be used, the packaging material will act as a protection of the material, not only

with regard to temperature and moisture, but also from possible damage from scraping, dropping, etc.

- If possible, it is always advisable to transfer the material to the pressroom some time before use, so that it can adapt to the temperature and moisture conditions of the area, so that it does not undergo changes when going into print. A reasonable time to prevent spoilage due to this will usually be 24 to 48 hours.

Removal of dust from the surface of the support prior to printing:

Dust on the surface of the support causes considerable spoilage when printing materials such as cardboard, as it forms plugs during the printing process, leading to printing defects that give rise to reruns, machine stoppages, etc. Installing suction devices at the point where the support enters the machine to remove the dry dust from the surface minimises flaws. The approximate cost for each printing machine is around 21,000 euros.

Reuse of macules:

During the print run there are phases in which faulty printing work called macules are generated, which must be removed from the printing work and thus contribute to the production waste. Generally, the macules are directly managed as waste, without any other operation being carried out with them. At this stage, however, the macules can be reused to adjust the colour at the beginning of subsequent print runs. This fact should help to minimise the overall waste generated during the print run, as well as to reduce the amount of support required for each job. It should be borne in mind that sheets can only be reused if they are in good condition (they should not be wrinkled, torn, dirty, etc.).

Improvements in colour preparation:

Traditionally, special colours are prepared manually, using other colours and using the most convenient method with the available instruments, or otherwise the one learned within the company itself from carrying out this task on a daily basis. Nevertheless these preparation processes are not always as precise or reliable as they could be, a fact that may lead to more time wasting in both the preparation and the subsequent colour adjustments at the beginning of the print run, and the generation of a whole series of production wastes that could have been avoided had the operation been better controlled. In this sense it is recommended that the work method start with the use of precision scales in order to accurately weigh out the proportions of the basic inks for preparing the colour, so that the proportions of each ink added are as accurate as possible. Next comes the colorimetry and proofs during colour preparation, to achieve the desired result in the shortest possible time and with the lowest material consumption. Finally, the colorimetric data should be gathered, such as the proportions and method used to achieve the result, so that the next time the same colour is required for the same client, the desired result can be achieved more quickly.

Carrying out of the Ishihara test on the personnel involved in colour preparation and control:

For the colour to be properly assessed it is essential that all the machine operators, and all the staff involved in colour preparation in the printing and allied industries are not colour-blind. This fact becomes especially important in the case of companies where the assessment of the colour is done only by means of a visual check.

Colour-blindness can be detected by carrying out the Ishihara test. This test consists in looking at a series of sheets with colour images. In the test, the people with normal colour vision can easily see all the sheets, whereas those with colour vision impairment have difficulties with at least some of the images. In this case the appropriate action should be taken.

Work planning and the creation of a spoilage register:

In general terms, proper work planning is essential to identify and reduce spoilage, and to be able to detect the factors that cause unexpected increases, and to thus be able to take quick action to solve them.

In order to properly carry out this planning it is important to create a register of the spoilage generated giving information on the amount of paper lost, the causes of this loss, the person responsible, the excess inks and consequently containers used, the solvents used, etc.

In general this involves creating a register that enables the causes of material losses to be known at all times and that serves as a basis on which to establish corrective action in this sense.

Although this is not an action that leads directly to a reduction in spoilage, it does create a favourable management environment.

In fact all the companies that have Quality Management Systems and Environmental Management Systems already provide for this. However, these should be dynamic documents with which improvement objectives can easily be set, and that enable the company to advance in an ongoing improvement plan.

Elimination of systematic stoppages:

This is a basic aspect that should be taken into account, as each time the machines stop spoilage is generated, of varying importance, that becomes a part of the overall production waste. It should be remembered that when starting up the machines once again, it will be necessary to adjust the printing parameters, the colour, the viscosity of the inks, etc

In order to eliminate systematic and compulsory staff stoppages, in the companies where this is still done, it is necessary to plan and organise shifts, so that at any given time there is someone checking on the printing process, without it being necessary to stop it.

Machine maintenance and cleaning of the press room:

The last point in this summary of options to improve production control and the quality of the process, and is related to the internal organisation of a preventive maintenance and cleaning programme for the pressroom.

Firstly, it is of interest to design a machine maintenance programme so that regular reviews and maintenance are carried out at different levels. This reduces spoilage caused by the need for urgent repair of a machine when a problem arises and not on a preventive basis.

Moreover, the cleaning of the pressrooms becomes an important aspect in the improvement of the quality of the printed work and in the minimisation of spoilage. A dirty work area may affect the printing process, as at any time the dust on the floor and on objects may cause faulty printing, creating plugs, etc. It is therefore considered essential to maximise the overall cleaning of the work area. One solution is that the machine operators themselves take care of these tasks. Thus, it is better to clean the machines or the work area during and immediately after use, using small quantities of cleaning products repeatedly, instead of using the whole amount of the product in a single cleaning process. Besides, continuous cleaning above all prevents the ink remnants from drying out. Thus, the first cleaning can be dry, saving the addition of cleaning products for the final cleaning process.

Changes in raw materials purchasing management:

A new approach in the management of raw materials may contribute to minimising waste flows. In fact, the generation of empty containers throughout the printing and allied industries, once the material they contain have been used; generate a significant volume of waste. Frequently and for merely practical reasons, the products used (above all inks and solvents) are usually purchased in relatively small containers considering the company's consumption of these products, and which have to be managed as waste once empty. This point has an even greater incidence in the case of inks, especially if non-reusable special colours are used. Thus, whereas the consumption of relatively small quantities of raw materials may have some advantages, such as more simple transfer processes, the guarantee of non-obsolescence of the products or a lesser loss of materials should the container leak, it is also true that the management of the waste becomes significantly more complicated, as it translates into the generation of many very small containers.

On the other hand, if large containers are purchased, one has a few very large-volume containers, which the supplier of the products often wishes to recover, with which the management of these wastes is significantly reduced or even, in some cases, unnecessary.

In addition, and apart from the improved management of these wastes, better raw materials management is also achieved, as the products in large containers offer a better yield, and warehouse management is streamlined. Even so, all that can be expected from adopting this measure is a cost improvement, an improvement that can only be assessed after the fact in each case. It should nevertheless be taken into account that this change in purchasing management is not possible in all companies and with all materials. This fact will always depend on warehousing, the consumption of the product in the company, its expiry date, etc.

Protection measures against possible leakage and spillage:

It is very important, in the case of storing liquids, that protection measures are taken against possible leakage and spillage. In this sense, the companies should take into account:

- To concentrate all the liquid products in a single area (a warehouse for chemicals, liquids or flammable products) properly sized in accordance with the needs of the company, and including the relevant safety measures, separate from the rest of the factory and with a collection system for possible leaks and spills.
- To properly identify each product, whether it is a raw material or a liquid waste, so that it is properly labelled with its name and also a minimum indication of its hazardousness and the precautions that must be taken both in its storage and handling.
- To define a specific, delimited and signposted area in which to carry out the most important transfers, taking the necessary protection and measures with regard to possible incidents.
- To label the different liquid and gas supply lines, in order to identify immediately the cause of a problem should there be a leak.
- If drums with liquid products are needed in another part of the industrial building, they should be placed in an area sufficiently large to prevent collisions and in containment tanks that should be able to collect at least the volume of the containers placed on them.

In any event, the question is to ensure that none of the liquids that may be spilled on the premises can reach the floor and the sewage network, thus avoiding the risk of soil pollution.

The reduction of the contact surface area of the solvent with the air:

Solvent evaporation in flexography or rotogravure companies may reach very significant levels. Thus, in working with liquid inks where the ink fountains are normally left open, the viscosity of the inks must be adjusted on an ongoing basis, as the solvent evaporates.

In fact open solvent containers are often to be found throughout the entire work area, which makes them easier to use, either directly or in liquid form, or by means of cleaning rags. This all adds up to the generation of solvent vapours that remain in the work area, which may reach significant levels of concentration and involve a significant loss of product. It is good housekeeping to close the containers should be closed each time they have been used. With this simple action the cost savings achieved by solvent consumption reduction, can be quite considerable.

Control of certain production parameters:

There are different parameters that should be controlled in order to ensure that the work is carried out as efficiently as possible. These parameters can be numerous and very different, depending on the work method and the specific needs of the company; three are especially noteworthy:

- *Control of solvents consumption:* one of the products that are consumed most in printing companies, apart from the supports and the inks are the solvents that are used for diluting and cleaning. This control, which logically becomes more important in rotogravure and flexography companies, is important as it enables identification of the different uses of the solvents and the quantities allocated for each of these uses, and using this as a starting point to set objectives and/or measures for reducing their consumption.
- *Control of the print run costs:* this is closely related to the point that refers to the reduction of production waste, as knowing the print run costs more or less exactly means the economic cost of the losses generated can be evaluated, and the possible reductions that can be achieved can be defined on a clear, realistic basis. The companies that have installed a quality management system already control their print run costs.
- *Control of the environmental aspects:* as in the previous cases, knowledge of the factors relating to different tasks, improvement objectives to be set. In this sense, the knowledge of the environmental parameters, which affect the print run, must lead to their improvement, always based on precise knowledge of the specific aspect to be improved.

General Good housekeeping practices:

Below, a series of Good Housekeeping Practices are described that can also involve a reduction in the consumption of raw materials, as well as the minimisation of the waste flows generated. These recommendations are structured into work sections which describe the general Good Housekeeping Practices that can be put into practice.

GOOD HOUSEKEEPING PRACTICES: PURCHASING - WAREHOUSING

- Inspect the materials before they are accepted.
- Implement agile production systems, reducing stocks that may expire.
- When assessing the cost of a raw material, take environmental criteria into account.
- Describe the safety and procedure rules in case of emergency, with safety sheets for the handling, transport and proper storage of the substances.
- Before buying or renting machinery, compare the energy consumption of similar models from different manufacturers.

GOOD HOUSEKEEPING PRACTICES: DURING THE PROCESS

- Reuse the ink from the printing stage. Ink remnants can be mixed to make black inks that can subsequently be used in specific applications.
- Separate and recycle the remains of photographic film and paper left over from photomechanics.
- The rinse waters that contain developers should be treated, or failing this be separately collected as wastewater and properly managed.
- Reuse or recycle printing plates.
- Encase the printing machine, combining the air purification processes, to minimise the emissions of volatile organic compounds.
- Cover the printing machine or a part of it to reduce noise levels
- The printing machines should have tanks for collecting ink spills.
- Separate the wastes generated during the process.
- Develop operating guides or manuals for utilising materials and equipment.
- Keep a register of the data on waste generation, wastewater run off and air emissions of each operation and the related costs.
- Contribute to waste reduction by studying the feasibility of utilising by-products and the option of reprocessing products that have not achieved optimal quality.

GOOD HOUSEKEEPING PRACTICES: MAINTENANCE

- Use the instruction sheets for the operations and maintenance recommended by the manufacturer of the machines and devices.
- Carry out frequent inspections of the plumbing installation to detect leaks and therefore over-consumption due to breakdowns.
- Create a history file of the machines.
- Monitor the cost evolution of each machine, including the waste and emissions generated.
- Verify compliance with safety instructions.
- Separate the waste according to whether or not it can be recycled.
- Use mechanical means to clean the installations (brushes, brooms), to minimise the consumption of cleaning liquids associated to the cleaning activities.
- Avoid the discharge of any waste or polluted water into the general sewage system.
- Reuse cleaning rags.

GOOD HOUSEKEEPING PRACTICES: OFFICES - GENERAL SERVICES

- Establish a water balance in the company, determining the input and output flows, as well as the requirements.
- Minimise the number hours of the heating and lighting systems are in use by installing automatic mechanisms to control their start-up.
- Insulating the building, especially office windows, leads to considerable energy savings, as it prevents loss of heat in the winter and of cool air in the summer.
- Make workers aware of the importance of saving energy in the course of their work.
- Use ecological or recycled paper for letters, invoices, computer printer paper, notepads, etc.
- In the offices use paper on both sides and reuse envelopes for internal correspondence.
- Ascertain what paper is used and what percentage can be recycled to set reduction objectives for the waste generated in this area.
- Install timers that switch off lights after a certain period of time (toilets, changing rooms) or presence sensing devices that switch the lights on and off in passage ways: this significantly reduces electricity consumption.

6.2. ALTERNATIVES TO RECYCLING AT SOURCE

Once the viable forms of reduction at source have been applied, recycling at source should be considered as a second option, in other words the reusing of the waste flow that inevitably occurs within the process itself or within the department that generates it. Let us consider a few examples:

Reduction of liquid wastes from the film processing stage:

In the film processing stage there are minimisation options that consist in installing recovery or recycling equipment on the baths used, for their subsequent reuse. The main device would be the one to minimise the fixer and recover the silver from the film, as the silver is the most polluting of the elements that are present in the solutions, apart from the fact that the rinse water, this becomes contaminated due to drag-out making it necessary to subsequently treat it as a waste. In its operation, the recovery unit is connected in line with the fixer tank, recovering the silver by means of an electrolysis process and supplying the treated fixer to the film processing machine. This achieves an extension of the useful life of the fixer and therefore reduces the quantity of waste liquid generated by approximately 50%, and in addition it prevents the contamination of the rinse water with silver. Apart from electrolysis, there are other technologies for silver recovery that include precipitation, ionic exchange, reverse osmosis, evaporation, etc.

There are also devices on the market for recovering the film developer and recirculation and treatment systems for the rinse water, although these must be installed when the fixer minimisation and silver recovery devices are not sufficient on their own to maintain the wastewater discharge parameters below the legally established limits. The filtration unit is connected to the developing tank of the automatic processor, with the aim of extending the useful life of the developer and reducing the amount of chemicals consumed to maintain the concentration stable. In this case, the cost reduction will arise from reductions in developer consumption and the management costs of the spent bath.

Reduction of liquid wastes from the offset platemaking:

As for film processing, a processor is also used for developing plates, which in this case contains a developer bath, a rinsing or washing bath with fresh water and a rubber bath for protecting the plate until it is used.

There are therefore, several ways in which to minimise the generation of liquid waste in platemaking. Firstly, the amount of developer used by the processor can be minimised by means of a filtration system. Its operation is very simple, as instead of collecting the developer in a tank for its subsequent management, it is sent to a recycling tank where it is simply

passed through a filter. At the same time a part of the developer is regenerated. By using this system one can save up to 50% of the developer used.

Furthermore, there is also a very clear option for the minimising the rinse water, which is generally fresh water that is used only once, basically to ensure that it is very clean and that it works as effectively as possible. In this rinsing operation water consumption can be minimised by installing a filtration and recycling system. The installation of this type of device will involve a saving of 90% of the water used in the process.

This system is very simple; it is based on the collection, filtration and subsequent recirculation of the water used. The unit comprises a tank with a pump that recycles the water and a set of activated charcoal and resin filters to purify it, thus allowing it to be reused. However, it does not work constantly with the same water, as there is usually a small input of fresh water as well as a small output of used water, to maintain ideal working conditions.

Manufacturing black inks from surplus inks:

Although in general terms waste ink does not lead to significant waste flows, it does become a long-term management problem. In this sense and in accordance with the recycling concept, making black inks from the leftovers of other inks is an interesting option, as these can be used again in the printing process.

Manufacturing them is a very simple process, so it should be easy to carry out tests to establish a monitoring period in which to analyse feasibility. Thus it is only necessary to allocate an area close to the machines in the press room for a specific tank or drum, correctly indicated and labelled, where ink wastes can be dumped and mixed taking into account that light or very bright colours should not be used to produce black inks as they could affect the final colour and that the mixing of the different inks may not lead to a true black but something closer to dark brown.

Therefore, the reuse of these inks entails a minimisation in waste management.

The minimisation of production liquid waste by installing an evaporator:

The reduction of water-based liquid wastes generated during the production process and cleaning operations, that often imply the generation of a significant volume of wastewaters, may give rise to a significant opportunity for recycling.

With regard to the management of these wastewaters, companies have the option of either outsourcing their management or managing them internally by installing evaporation equipment.

This system comprises an evaporator and a subsequent condensation chamber, which collects the steam in the liquid phase. It is a completely closed system and it uses a heat pump and a vacuum system with which evaporation is achieved at a low temperature, saving energy and reducing costs.

It therefore operates based on the vacuum distillation principle, where the necessary heating energy to make the wastewater boil is obtained by means of a heat pump. The temperature of the solution increases sufficiently to cause it to boil in the vacuum that has been created. The steam rises from the boiling chamber and condenses within the coils of the condensation chamber. On condensing, the water flows down through the coil and is collected at the bottom of a condensation tank, from where it is sucked up by an ejector and transferred to a tank.

Therefore, in addition to installing the main equipment, it will be necessary to install two tanks: one for the incoming waters and the other for the outgoing waters, which ensures a constant flow in the evaporator for improved performance. It is in these two tanks where the quality of the incoming and outgoing water can be monitored. As a consequence of this process, however, it should be borne in mind that concentrated sludge generated will need to be treated as waste. Nevertheless, the fact that the sludge has to be treated instead of wastewater involves certain benefits, as on the one hand the water is being reused in the company itself, the waste volume to be managed is much lower and it has a pasty consistency, which is much easier to store and transport, thus significantly reducing the environmental hazards associated with these operations.

In general, the suppliers of these systems guarantee the recovery of up to 90% of the treated water, despite the fact that for technical and economic reasons it is recommended to set the recovery level at around 80%. For the proper operation of the installation, it should be borne in mind that volatile solvents cannot be used, as this would impair the normal operation of the device, apart from the fact that the treated water would not be suitable for its subsequent reuse. Consequently, the installation of equipment of this type implies a reduction in the consumption of water as a raw material, as the water treated by means of the evaporator can be reused within the company as cleaning water, for flushing toilets, etc., and the reduction of the liquid waste would thus become approximately 20% of the initial waste flows.

The minimisation of waste solvents by installing a distiller:

Another one of the waste flows that is fairly usual in the printing and allied industries is that of ink-soiled dirty solvents used for cleaning the machines. Although these dirty solvents are often discarded with the rags (above all when the cleaning is done manually) in some

companies they are collected selectively and are managed as a liquid waste. These solvents can also be generated in the automatic cleaning tunnels that are used in some companies, for cleaning ink trays and other implements with ink remnants.

Installing a distiller for its internal treatment thus minimises the amount of this type of waste that must be managed externally.

In general terms, the distillation equipment is virtually the same as that of the evaporator, with the same features, although its operating temperature is lower, as the solvent evaporates more easily than water. Moreover, as it works with solvents, the system must be completely hermetic and be fitted with an anti-explosion safety system.

Installing distillation equipment can achieve a recovery level of up to 90% of the treated dirty solvents, reducing the volume of waste to be treated for this reason to 10% of the initial waste. However, a new waste is generated: the distillation sludge from the solvents, which must be managed.

Therefore, the use of this equipment will both enable fewer solvents to be bought, as these can be reused, and lead to a decrease in the generation of waste solvents.

7. POLLUTION CONTROL METHODS*

Once the initiatives that enable waste flow prevention and reduction at source have been implemented, there is inevitably a final waste fraction that must be managed or treated in such a way as to pose no health to risk to humans or the environment.

With regard to the treatment methods used for pollution control, different technologies are used for the different waste flows arising from the printing and allied industries. These technologies are explained below:

7.1. TECHNOLOGIES FOR TREATING AIR EMISSIONS

There are two alternatives for achieving the appropriate emission parameters for atmospheric pollutants. The first consists in a preventive measure by means of reduction at source (these measures are explained in chapter 6), while the second involves the installation of equipment for capturing and treating the emissions, such as thermal oxidation, catalytic oxidation, absorption equipment, and adsorption or biological purification systems, among others.

The selection of the technology to be used depends on the type and concentration of the pollutants in the emission flow, and, although this can be complicated, it must resolve the problems that may arise in each specific case.

Therefore, in order for the chosen technology to be considered appropriate, it must provide sufficient yield to reduce the emission levels to below the maximum admissible limits, in a constant form and at affordable operating costs. The methods that have been developed for the treatment of polluting atmospheric effluents may be differentiated into two groups. The first encompasses all those that involve the separation of the VOCs from the waste flow and the second groups the methods for destroying the pollutants (mainly VOCs). The different technologies are described below:

* The source for the information of some of the technologies present in this chapter is the following web site: <http://www.wk-gmbh.com/español.html>. Other suitable technologies may also be found within the internet.

7.1.1. Separation technologies

7.1.1.1. Adsorption with activated charcoal filters

The adsorption technique applies a process in which the molecules of a gas adhere to a solid surface. Adsorbent solids are materials with an internal structure containing a great number of very tiny pores. The most usual adsorbent medium for treating volatile organic compounds is activated charcoal. As a result of the hydrophobic behaviour of its surface, activated charcoal preferably absorbs organic substances and other non-polar compounds that may be present in liquid or gaseous states.

The separation of the solvent in the liquid phase is obtained by the regeneration of the exhausted activated charcoal bed; this can be done by heating it, or subjecting it to a blast of nitrogen or steam. For cost and simplicity reasons, the technique that is most used for regeneration is direct steam injection. The steam rapidly heats the adsorbent bed, thus evaporating the adsorbed compounds.

By means of subsequent condensation, it is possible to separate the solvent used. The reuse of the separated liquid depends largely on it having the required properties. If it cannot be reused in the printing process, it is possible that it can be used in other processes or even in other industries.

The efficiency depends on the pollutant and on the adsorbent used, in addition to the concentration and working temperature and humidity.

This system is used where large volumes of air have to be treated with low or moderate concentrations of VOCs.

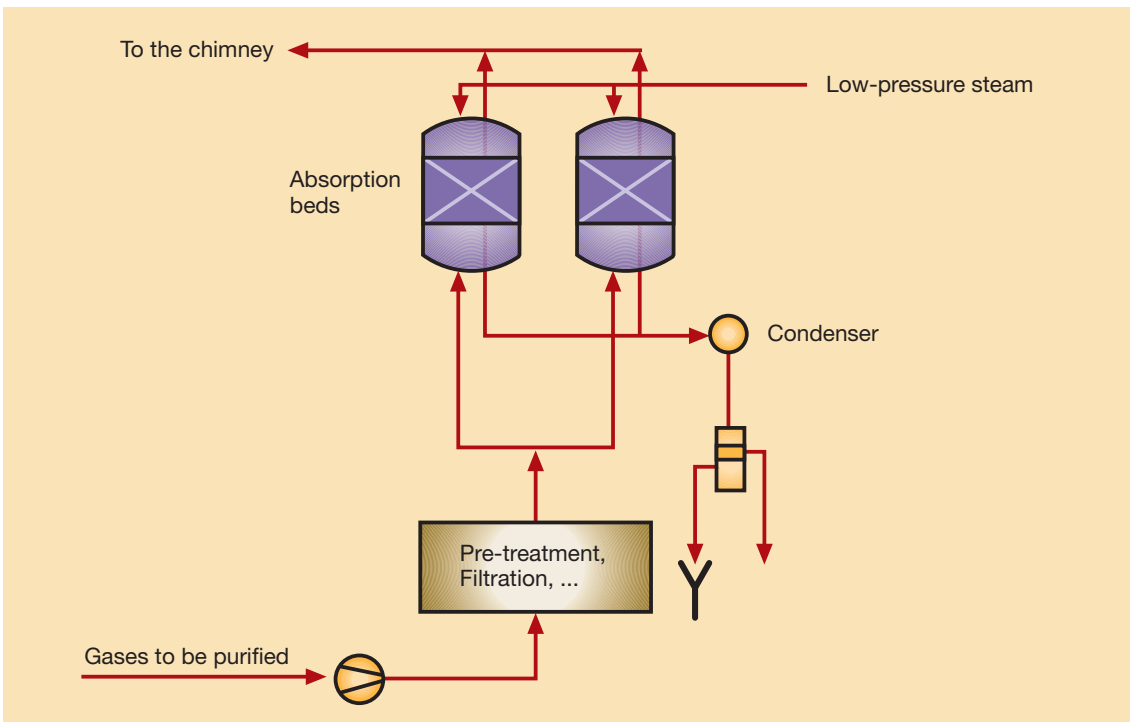

Adsorption operating diagram

7.1.1.2. Condensation

This technique is based on the cooling of the mixture of gases until the volatile organic compounds are transformed into a liquid or even a solid state. The freezing temperatures of these compounds are extremely low, for which reason cryogenic techniques are used. The agent used to produce this cooling effect is nitrogen, as its liquefaction temperature is -196°C .

In general, the steam pressure of the components that are present in a flow of volatile organic compounds decreases in proportion to its temperature, arriving at values that are very close to zero when at temperatures such as that of liquid nitrogen. This implies that the quantity of volatile organic compounds becomes minimal following its elimination due to the change in state.

The separation of the VOCs occurs as the pollutant condenses on the walls of the tubes, through which liquid nitrogen flows, as the condensate falls by gravity into a tank where the liquefied VOCs are stored. The reuse of the liquid obtained depends largely on it having the required properties. If it cannot be reused in the printing process, it is possible that it can be used in other processes or even in other industries.

The efficiency achieved with most of the VOCs recovered when working at about -50°C , is very high.

The system for separating volatile organic compounds by cryogenics is especially suited for waste flows that have high concentrations of volatile organic compounds and low volumes. These parameters are due to cost reasons (the investment cost plus the operating cost), even though this system is technically applicable to any volume and concentration of volatile organic compounds.

7.1.1.3. Membrane separation

This technique is based on the difference in permeability of dense polymer membranes in comparison with the volatile organic compounds and inert gases such as air. It enables the separation of certain organic compounds such as TCE, MTBE, acetone, and vinyl chloride, among others.

The separation of the VOCs consists in establishing an efficient contact between the polluting gas and the dense polymer membrane. The application of a pressure difference makes some compounds pass through the membrane. Thus two gas flows are generated, one of air and the other one of air enriched with the pollutants. The purification efficiency is low, even though it is achieved at reasonable operating costs. The exclusive objective is the purification of the emission; this technology must be combined with others with better performance levels.

The system for separating volatile organic compounds by means of membranes is especially suited for waste flows that have a high concentration of volatile organic compounds and low volumes. These parameters are due to cost reasons (the investment cost + the operating cost).

7.1.2. Destruction technologies

7.1.2.1. Thermal oxidation

This is basically a system that converts VOC emissions into water and carbon dioxide.

The thermal oxidation procedure starts with the forcing (1) of the polluted gases towards a pre-heating process using a heat exchanger (2) it continues with the oxidation process in the combustion chamber (3) at a reaction temperature of approximately $750\text{--}850^{\circ}\text{C}$ together with an additional fuel.

The dirty gas is held in this chamber between 0.6 and 1.5 seconds, and it is thus ensured that the clean gas output values will remain below a maximum emission limit.

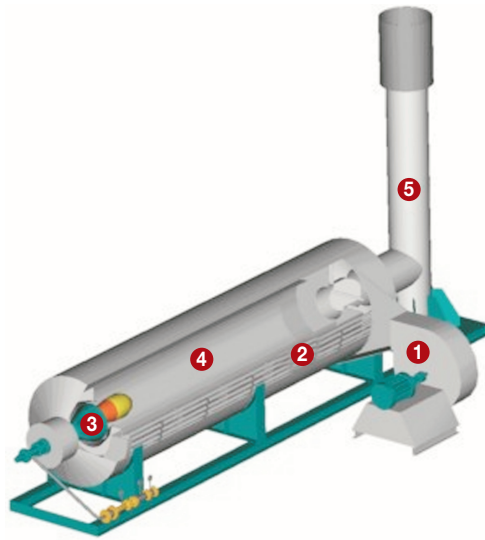

Recuperative thermal oxidation operating diagram

Subsequently the treated air is cooled in the same heat exchanger (2) and transfers its heat content to the incoming gases.

In general terms, thermal oxidation systems achieve a high degree of efficiency in eliminating pollutants, with low maintenance and investment costs, although they have high operating costs when there is no energy recovery.

This energy recovery may be recuperative or degenerative:

- The recuperative system uses an air-air heat exchanger, by means of metal tubes or plates, and it is capable of recovering up to 70% of the available heat from the output gas. The implementation of this system is recommended for low volumes and high and intermediate pollutant concentrations; in generating more heat on oxidation, it requires a lower level of heat recovery.
- The regenerative system uses a heat exchanger consisting of a static bed of pieces that are normally ceramic. All this filler is subdivided into different segments, where alternatively one part heats the incoming gases and the other cools the out-flowing gases. Heat recovery may reach 95% of the output energy, and for this reason the costs in fuel are low or non-existent. Generally these systems are slightly more costly to install than recuperative systems.

These systems are used for volumes with low or intermediate pollutant concentrations that require efficient heat recovery in order to eliminate the need for additional fuel.

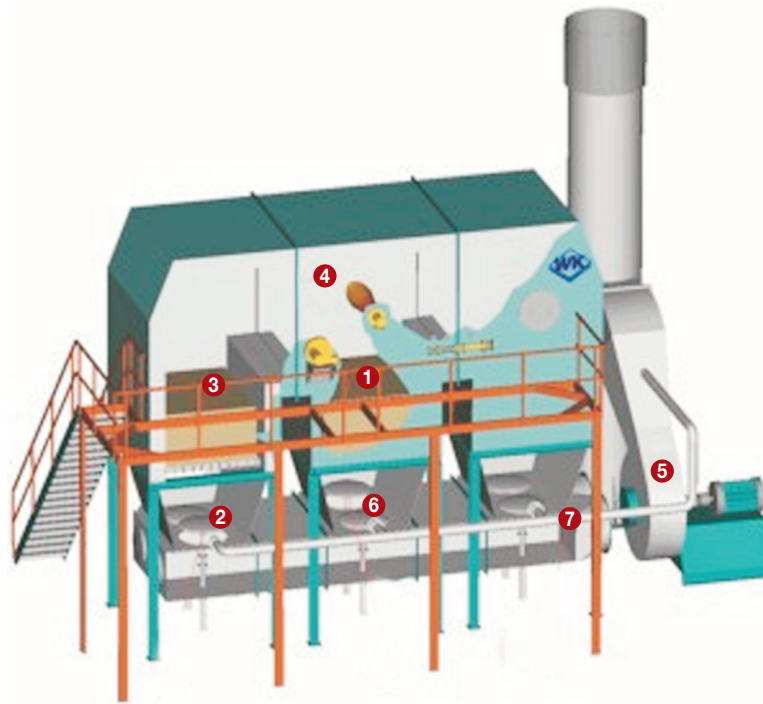

Regenerative thermal oxidation operating diagram

7.1.2.2. Catalytic oxidation

As in the previous case, this is a destructive system for splitting the gaseous pollutants into water and carbon dioxide; the main difference is that the temperature at which is destruction is achieved is lower when using catalytic oxidation.

In general terms, the operation first starts with the forcing (1) of the polluted gases towards a heat exchanger (2) which carries out the pre-heating process. Next, there is a combustion chamber (3) which operates at a temperature of some 250-450° C, and it is subsequently passed on to the post-combustion catalyst bed, where the organic components of the gas flow are oxidised (4).

It is not recommended to install this type of system when the VOCs contain compounds such as halogens, silicon, phosphorus, arsenic, or other heavy metals that are present in some types of ink, as these may poison the catalyst. The useful life of the catalyst under normal conditions is 3-5 years.

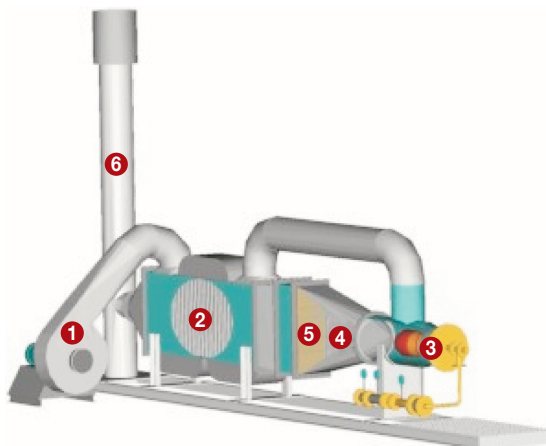

Catalytic oxidation operating diagram

Generally, the catalytic oxidation system will allow for the complete oxidation of a wide range of VOCs. It is however not a very useful technology when material particles are present, and it also has a high maintenance cost. Catalytic oxidation devices are recommended for low concentrations and volumes. It is under these conditions that higher efficiencies are achieved together with lower energy requirements.

As for thermal oxidation, the heat recovery from catalytic oxidation may be recuperative or regenerative; the regenerative system makes using additional fuel unnecessary.

7.1.2.3. Rotary VOC concentration system

This is a system that converts a certain volume and concentration, into a lower volume with a higher degree of concentration.

Generally, its operation starts with the forcing (4) of a volume of gases towards an adsorption system (1) where the pollutant is retained and where the purified gases are released into the atmosphere. Simultaneously, there is a secondary fan (6) that inputs a controlled volume of polluted air through the cooling area (2) of the adsorbent and then passes through a heat exchanger (9), so that it is heated up to the desorption temperature (3) and draws out the VOCs that were initially retained. This second air flow, which has a high organic load, is heated up in the heat exchanger (8) until it reaches the maximum possible temperature by means of the heat released by the gases that have already passed through the oxidation treatment process (7).

On being concentrated, the purification process treats a volume that is far lower than the initial volume, and it is therefore more cost effective and efficient. The last stage may be an oxidation process (as in this case) or a condensation system could also be used.

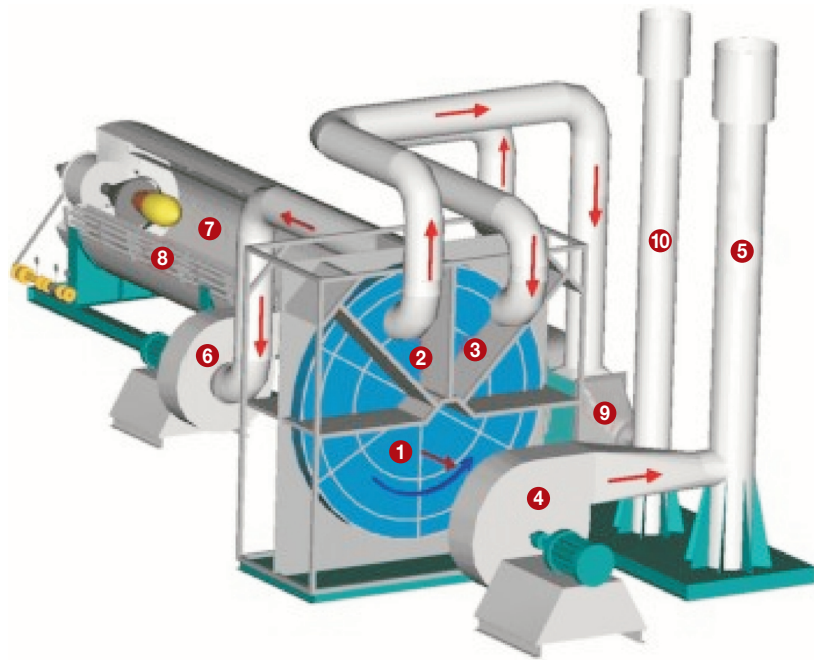

Rotary concentration system operating diagram

7.1.2.4. Absorption

Consists of a system where one or more components of the gas mixture are selectively transferred to a non-volatile liquid. The absorption of a gaseous component by a liquid will only take place if the liquid contains a lower concentration in pollutant parameters than that of the component saturation of the gases to be extracted. Thus, the difference between the actual concentrations in the liquid and the balancing concentration becomes the absorption strength.

Absorption may be carried out in different scrubbers. The absorption tower is the most used; it consists of a vertical column loaded with filler, in order to increase the time and the contact surface between the gas and the liquid, where the former passes through the filler, against the flow of the latter.

With soluble compounds high performance levels can be achieved for high concentrations and variable volumes, although it is essential that the air is free of particles and in addition it requires subsequent treatment of the wastewater.

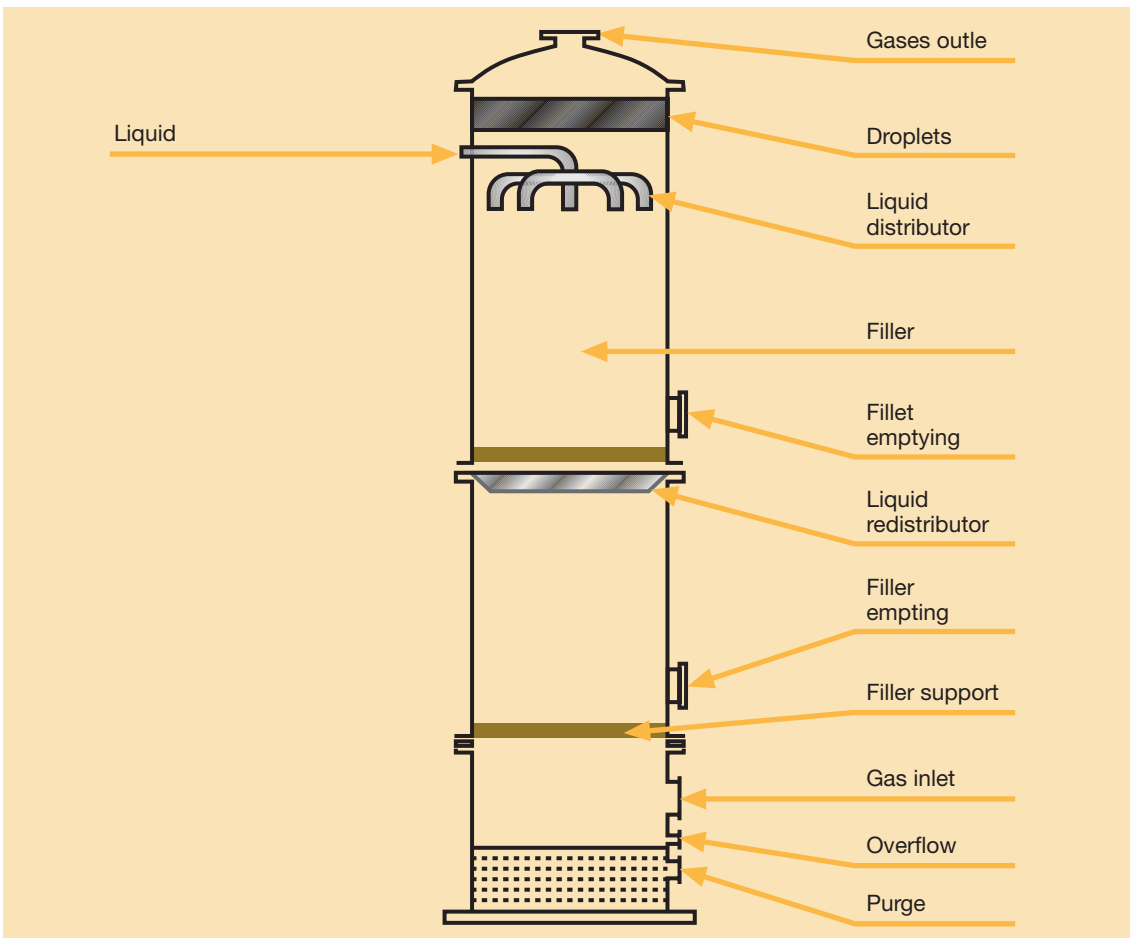

Absorption tower operating diagram

7.1.2.5. Biological purification

This consists in forcing the air through a bed containing bacteria or other microorganisms, eliminating the organic compounds by biodegradation.

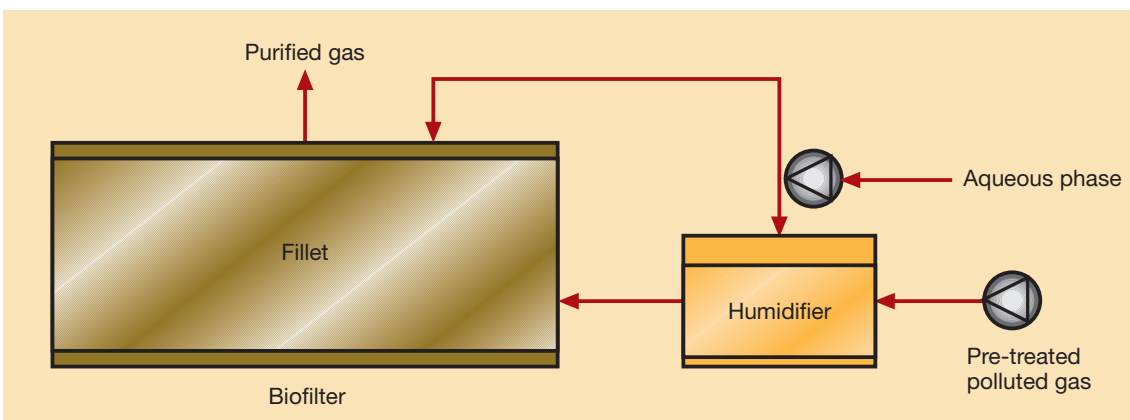

Biological purification operating diagram

Normally the air is pre-treated to eliminate any dust and oily aerosols it may contain, a wetting agent is added and it is transferred to the bio filter where the pollutants contained in the air flow are transferred to a film of water that coats the biologically active medium.

The microorganisms that are present in this film oxidise the pollutants, transforming them into harmless compounds such as carbon dioxide, water and common salts.

Its effectiveness depends on the type of pollutants to be treated, their concentration and the temperature. Biofiltration is an appropriate system when the concentration and composition conditions are at their most homogeneous; it obtains good results at low concentrations and with bad odour-related problems; with regard to volume, there are no restrictions.

To summarise the information given above, a generic table is attached, showing the main features of the different technologies for treating atmospheric effluents.

TECHNOLOGY	RECOVERY OF POLLUTANT	FLOW ²²	CONCENTRATION ²³	EFFICIENCY (%)
Adsorption	Possible	High	Intermediate Low	80-95 95-99
Condensation	Possible	Low	High	50-95
Membranes	Possible	Low	High	90
Recuperative thermal oxidation	No	Low	High Intermediate	>95
Regenerative thermal oxidation	No	Low and intermediate	Low	>95
Recuperative catalytic oxidation	No	Low	Intermediate Low	80-95 >95
Regenerative catalytic oxidation	No	Low and intermediate	Low	>95
Concentration system	Possible	High Intermediate	Low Very low	Variable ²⁴
Absorption	No	Intermediate Low	Intermediate High	95-98
Biofiltration	No	Any	Low	>99

Comparative table of treatment technologies for effluent volatile organic compound gases

²² Flows (Nm³/hr): High >200,000; Intermediate 30,000-200,000; Low < 30,000

²³ Concentration (ppm): Very low <1000; Low 1,000-5,000; Intermediate 5,000-10,000; High >10,000

²⁴ Depends on the subsequent treatment system (by heat, condensation)

7.2. WASTE TREATMENT TECHNOLOGIES

Once the possibilities for minimising the generated waste have been exhausted, as previously explained (chapter 6), only the option of managing it properly as a waste.

8. SUMMARY DOCUMENT

In general, the production process in the Printing and Allied Industries comprises the following stages:

- **Pre-press:** comprises the tasks required to obtain the printing plate or the printing form.
- **Printing:** technique for reproducing the printing form on the desired graphic support.
- **Post-press:** comprises the tasks required to obtain the finished printed product.

In the **pre-press phase** the following tasks are carried out:

- **Design** of the desired product.
- **Preparation of films:** the operations required to obtain the films:
 - photocomposition and photomechanics: obtaining of the text and the images.
 - film processing: includes the developing, fixing, rinsing and drying of the film.
 - typesetting and composition: a composition of the photographic material of the text and the photographic material of the illustration, to obtain an original to be reproduced.
- **Computer-to-Film (CTF):** The obtaining of the film directly from the computer, thus saving the intermediate phases (preparation of films).
- **Platemaking:** preparation of the image carrier, consisting in plates made of different materials and printing forms.
 - **Computer-to-plate (CTP):** The obtaining of the printing plates directly from the computer, thus saving the intermediate phases (platemaking).

The image carrier plate is obtained, by means of a set of operations that form a part of the pre-press process.

The techniques or types of **printing** are differentiated as follows:

- **Offset** printing: indirect printing, characterised by the fact that the image is transferred from the printing plate to the paper by means of the printing blanket.
- **Letterpress** printing: direct printing that uses forms in relief (plates) made of photopolymers. The image is transferred by the ink- impregnated form onto the printing support.
- **Flexography** printing: a printing method in relief, the ink is transferred by contact with the support to be printed, while pressure is applied by the impression cylinder.
- **Rotogravure** printing: the support is printed by contact with a metal cylinder, where the motif to be printed is engraved in the form of cells that retain the ink.

- **Screen** printing: printing on the material through the printing form (fabric) and not by transfer of the ink from the printing form.
- **Digital** printing: non-impact printing, in other words without contact between the printing head and the support, done using devices that digital information to pass directly onto paper.

The overall objective of the printing stage is to obtain the text and/or illustrations on the desired material or support.

Post-press: In order to obtain the finished product the following operations are carried out:

- **Binding:** the joining of the signatures of a printed work, in an organised manner, to form a compact volume by means of a solid seam, and add a consistent cover to protect the book and facilitate its use.
- **Cutting:** the operation to give the printed product the required size.
- **Folding:** the obtaining of a folded signature with a marked edged obtained by pressure, in order to eliminate the recovery properties inherent to the paper.
- **Stacking:** the placing of the signatures that form the book one beside the other until they form the complete block.
- **Milling:** the operation for grinding down the surface of the spine of the book, to prepare it for the gluing operation.
- **Gluing:** The operation for joining the different elements that have to be glued together (spine of the book).
- **Stamping:** consists in adding metallic embossed elements as a highlight to the covers of the book or any printed matter.

The main waste flows that are generated during the **pre-press** phase are as follows:

- **Air emissions**
 - The solvent vapours of the spray glues that are used for film composition.
 - The solvent vapours generated from cleaning the composition sheets.
 - The solvent vapours from the heat-hardening process of the plates.
 - Ammonia vapours generated in the ozalids.
- **Liquid waste**
 - Spent chemicals with silver wastes from the film processor (developer and fixer).
 - Rinse water from film processing, which may contain waste fixer liquid as well as waste silver.

- Spent alkaline solutions, with waste resins, colouring agents and diazo components, from the offset plates processor (developer).
- Rinse water from offset platemaking that may contain chemicals used during the developing process.
- Water from the processing of flexography and letterpress plates, with solid and semisolid photopolymer wastes.
- A mixture of water and solvents from the preparation of screen printing screens.

The main waste flows generated during the **printing** phase are as follows:

• **Air emissions**

- Solvent vapours generated during the process of preparing the inks and varnishes.
- Solvent emissions generated during drying process of the inks and varnishes.
- Fountain solution vapours.
- Emissions generated during printing and viscosity adjustment.
- Emissions generated during cleaning operations using solvents.

• **Liquid waste**

- Fountain solution containing waste inks, solvents and products such as algaecides, fungicides, etc.
- Waste liquid inks and varnishes.
- Solvent wastes from the cleaning operations of the implements used during the printing process (cylinders, ink fountains, doctor blades, etc.).

The main waste flows generated during the **post-press** phase are as follows:

• **Air emissions**

- Emissions of VOCs arising from solvent-based glues.

• **Liquid waste**

- Waste oils.

The **solid wastes** are not classified in accordance with the process stages in which they are generated, as the same type of waste may be generated in different stages.

<ul style="list-style-type: none"> • Films • Printing plates • Cleaning rags • Composition sheets • Solid waste ink • Plastic coating film • Toner cartridges • Hardened waste glue • General factory waste 	<ul style="list-style-type: none"> • Printing paper • Support plastics • Paper and cardboard packaging • Rubber (offset printing) • Sludge from liquid waste treatment • Filters and filtration cartridges • Metal and plastic containers • Waste oils
--	--

The **wastewaters** generated during the pre-press and printing processes, have been described in this manual under the solid waste section. As the volumes are not very great, and due to their main characteristics and pollution potential, there is a trend in the business to collect the flow and manage it by means of authorised treatment companies. Similarly, however, there are many companies that treat these waters in their internal treatment plants.

Summary tables are attached containing the main **alternatives for reduction and recycling at source** in the pre-press, printing and post-press phases.

REDUCTION AND RECYCLING AT SOURCE IN THE PRE-PRESS PHASE

Redesign of products

- The study of the printing design

Changes in technologies

- Programme for the reception and control of work received in computer-readable format
- The installation of a Computer-to-Film (CTF) and a Computer-to-Plate (CTP) system

Good Housekeeping Practices in the pre-press process

- The application of a floating plastic cover to avoid oxidation of the developer

Recycling at source

- The installation of recovery and recycling devices on the chemical baths used for film processing
- Filtration system on the chemical baths used for processing offset plates

REDUCTION AND RECYCLING AT SOURCE IN THE PRINTING PHASE

Raw Materials Substitution

- The change of cleaning solvents in offset printing
 - Water-based emulsions
 - Vegetable ester solutions
- The use of vegetable oil inks
- The use of ultraviolet (UV) inks
- The use of electron beam (EB) inks
- The use of water-based inks
- Alternative fountain solutions combined with additives

Changes in technologies

- The use of waterless offset printing systems
- Fountain solution filtration systems in offset machines
- Installations for the elimination of isopropyl alcohol from the fountain solution
 - State-of-the-art fountain system
 - Water oxygenation
- Colour measuring facilities: densitometers, colorimeters or spectrodensitometers
- Automatic solvent addition system for rotogravure and flexography printing machines
- The installation of closed-chamber ink fountains on flexography machines
- Dispensing system for ink dosage
- Systems for cleaning implements with ink remnants
 - Manual cleaning device for ink containers
 - The installation of automatic squeegee cleaners
 - Automated cleaning tunnel for ink fountains and others

Good Housekeeping Practices

- Quality control of the production processes in order to minimise losses during printing
 - Control scales in the preparation of offset plates
 - Lighting in the area for preparing offset plates and screens for screen printing
 - Improvement of the Pantone charts and the colour control strips
 - Conductivity measurement of the fountain solution in offset printing
 - Conditioning of the support prior to printing
 - Elimination of dust from the surface of the support prior to printing
 - The reuse of the macules
 - Improvements in colour preparation
 - The carrying out of the Ishihara test on the personnel involved in colour preparation and control
 - Work planning and the creation of a spoilage register
 - Elimination of systematic stoppages
 - Machine maintenance and cleaning of the printing area

- Changes in raw material purchasing management
- Protection measures against possible leakage and spillage
- The reduction of the contact surface area of the solvent with the air
- Control of certain production parameters
 - Solvent consumption control
 - Print run cost control
 - Environmental control considerations

Recycling at source

- Manufacturing black inks from surplus inks
- The installation of an evaporator
- The installation of a distiller

REDUCTION AND RECYCLING AT SOURCE IN THE POST-PRESS PHASE

Raw Materials Substitution

- The use of water-based glues or glues containing less solvent

We have described **pollution control methods** for management and/or treatment, which do not pose a health risk to humans or the environment, and the final waste fraction that inevitably arises once the actions for prevention and reduction at source have been implemented.

AIR EMISSIONS TREATMENT TECHNOLOGIES

- Adsorption with activated charcoal filters
- Condensation
- Membrane separation
- Thermal oxidation
- Catalytic oxidation
- Rotary VOC concentration system
- Absorption
- Biological purification

9. SOME EXAMPLES OF THE PROPOSED ALTERNATIVES

INSTALLATION OF A COMPUTER-TO-PLATE SYSTEM

A company in the business of making different products such as commercial printing assignments, forms and also magazines or packaging, using offset printing presses on paper or cardboard. This is an SME that has undergone a profound transformation over the past few years, introducing new machinery in order to continue evolving with the modernisation process of the printing and allied industries.

Considerations:

The production process of this company includes all the production stages of the printing industry. It starts with pre-press in which the product design, film processing and platemaking are carried out. It continues with the printing stage in which the desired product is obtained, and ends with the finishing stage where the product is tailored to the required end format. It was in the pre-press stage where it was considered that more modern technology was required in order to improve the service to customers and expand the production capacity for platemaking. Thus, within the overall set of operations comprised by both the pre-press and the specific printing operations, there is an option that affords benefits in both the minimisation of waste flows and its inherently improved technology. This option is the implementation of a Computer-to-Plate (CTP) system.

Summary of the initiative:

The Computer-to-Plate system allows for digitalised image information to be passed directly onto an offset printing plate, which avoids the preparation of films and the manual typesetting and composition required for subsequently obtaining the printing plate. In the old system, once the plate had been obtained, it was necessary to forward it to the processor to develop it, and then the plate could be used for printing.

With the installation of the CTP, certain technical and environmental improvements were achieved, among which it is worth highlighting:

- The suppression or a very significant decrease in the consumption of film and of all the chemicals relating to its processing, as well as the related waste flows.
- The shortening of the production cycle and the consequent labour saving, as the time to obtain the plates was shortened.

- Reduced consumption of raw materials.
- Improvement in quality: with CTP, the quality of the plates obtained using this process is better, as the points etched onto the plates are much more precise, sharp and fine. Thus their response when printing is much more reliable and consistent.

The printing company that adopted this CTP technology had a plate production capacity of 35 units in 8 hours, whereas with CTP the capacity is of 105 plates in the same amount of time. With this new system the company presently produces 11,550 plates, corresponding to 50% of the new capacity of the equipment. The format of the plates is 70 x 100 cm.

Balances:

MATERIAL BALANCE	OLD PROCESS	NEW PROCESS
Film	5,390 m ² /year	-
Film developer (0.15 litres/m ²)	800 litres/year	-
Film fixer (0.15 litres/m ²)	800 litres/year	-
Film rinse water (8.5 litres/m ²)	46 m ³ /year	-
Plate developer (0.25 litres/m ²)	1,347 litres/year	2,021 litres/year
Plate rinse water (1 litres/m ²)	5 m ³ /year	8 m ³ /year
Plates	5,390 m ² /year (7,700 plates/year)	-
CTP plates	-	8,085 m ² /year 11,550 plates/year

ECONOMIC BALANCE	OLD PROCESS	NEW PROCESS
Film	21,000 €/year	-
Film developer	2,400 €/year	-
Film fixer	2,300 €/year	-
Film rinse water	32.2 €/year	-
Plates	26,500 €/year	75,000 €/year
Plate developer	3,950 €/year	9,933 €/year
Plate rinse water	3.5 €/year	6.0 €/year
Film management	175 €/year	-
Film developer management	450 €/year	-
Film fixer management	225 €/year	-
Plate developer management	5,500 €/year	9,225 €/year
Plates management	0 €/year	0 €/year
Total cost	62,535.70 €	90,164 €
Unit cost	8.12 €/u	7.80 €/u

Overall increase in pre-press expenses:	27,628.30 €/year
Labour saving in pre-press expenses:	89,900.00 €/year
Annual pre-press saving:	61,371.70 €
Investment in installations:	300,000.00 €
Payback period:	4.8 years

Conclusions:

With this initiative the company managed to save 100% of the cost of film, as well as the associated costs for processing it (developer, fixer and rinse water) and also the waste flows of this pre-press process phase.

It is especially important to point out that this automation achieved a significant shortening of the production cycle, above all with regard to the elimination of manual tasks, allowing the company to relocate the workers to other phases of the printing process and improve planning and control in the rest of the processes.

This is a clear example of how the introduction of new technologies involves, in addition to an improvement in quality and productivity, an environmental improvement that justifies the investment made.

INSTALLATION OF AN INK DISPENSING SYSTEM

In this example we will explain the case of a company that largely manufactures flexible containers for the food industry, with its main activity centred on printing and laminating different types of support. The company has different machines for rotogravure printing on plastic support, specifically polypropylene and polyethylene. It is an SME that has undergone great changes in its process of updating to the new emerging technologies of the printing and allied industries.

Considerations:

The ink preparation process was a process that the company carried out manually. It consisted in mixing different ink colours in order to obtain the required colour following a series of preset instructions, which indicated the amount by weight of each basic colour or the ink was otherwise purchased from the supplier, and was then warehoused. The mixture was prepared in the same drums the ink was supplied in, with the help of a set of scales, the ink then being transferred by means of a large ladle. Next, the viscosity of the ink was adjusted by adding ethyl acetate that was required for the proper operation of the printing machines, by manually adding a 40% solvent component. Virtually all the ink preparation operations were carried out in a part of the industrial building set aside for the purpose, and the drums containing the ink would then be transferred to the ink fountains on the printing machines.

The variety of colours that were used implied a considerable need for raw materials storage, and consequently a significant volume of empty containers to be managed as waste.

Objective:

The reasons that led the company to undertake this initiative were the following:

- To reduce waste container generation.
- To reduce the stock of inks through optimal inventory control.
- A uniform and unvarying colour, offering perfect printing.
- To reduce the final cost of the inks as these could be purchased in bulk.
- To avoid losses from the ink remnants with the containers managed as waste.
- To obtain the exact quantity of ink for each specific print run, minimising leftover ink.
- To recover the inks left over from a print run, by reusing them.
- To avoid the manual handling of the inks to the utmost, as this was a source of errors and significant spillages.
- To minimise the air emissions of organic solvents, arising from the transfers of inks and from the manual mixing of inks.
- Quick and precise availability of the ink.

With this set of objectives in mind, the company decided to install a liquid ink dispensing system.

Summary of the initiative:

The dispensing system is a system for mixing the colours and diluting inks for printing on supports. By the software of the system itself, the required inks are prepared in accordance with the support to be printed. It is necessary to have a number of single-pigment concentrates available, stored in tanks varying from 200 to 1,000 kg, and a system of pumps and pipes controlled by a computer for the automatical dosage of the inks into the desired container.

In order to set the doses for a given quantity of a sample, a spectrophotometer is required for recognising the colour of the sample, as is the necessary software for controlling the formulation and the quality of the colour. Thus, once the colour has been recognised, the software ascertains the quantity that is required from each tank in order to prepare the desired colour, and by means of a set of pneumatically activated valves, and a set of scales that dose out the printing ink, the ordered request is obtained. This system is hermetic and the transition from the colour-mixing phase to the ink dilution phase and to the printing on supports is done by direct injection, without using drums. Thus, solvent vapours are reduced.

The tanks do not have to be managed as waste, as they are returned to the supplier, to be refilled; in this case a total of 16 tanks have been installed for the required raw materials.

The system also calculates the required quantity for a given print run, and in addition, should surplus inks arise from the print run, it is capable of reusing them and producing another colour.

Balances:

MATERIAL BALANCE	OLD PROCESS	NEW PROCESS
Ink consumption	100 tn	80 tn
Solvent consumption	19.35 tn/year	2.90 tn/year
Waste metal containers generated	2.5 tn/year	0.625 tn/year
Waste inks generated	3 tn	0

ECONOMIC BALANCE	OLD PROCESS	NEW PROCESS
Ink cost (3.31 €/kg)	330,556.66 €/year	264,445.33 €/year
Solvent cost (0.9 €/kg)	17,444.38 €/year	2,614.40 €/year
Cost of managing metal containers (0.30 €/kg)	750 €/year	187,5 €/year
Ink management cost (0.75 €/kg)	2.250 €/year	0 €/year
TOTAL COST	351,001.04 €/year	267,247.23 €/year

Total annual saving:	83,753.81 €
Investment in installations:	156,263.15 €
Payback period:	1.86 years

Conclusions:

With this initiative for automating the formulation and distribution of inks, the company has been able to regularise utilisation of the liquid inks used to print the packaging products it makes. The main environmental benefits obtained are:

- the elimination of surplus inks by 100%
- an 80% reduction in container waste
- the overall reduction of solvent air emissions the atmosphere
- a time saving due to the automation of the system
- an estimated 35% reduction in inventory levels
- the immediate availability of the required colour
- and improvement in the quality of printed materials, due to perfect printing using colours prepared with the new system

This example demonstrates that technological change not only involves an improvement for the environment, but also a series of significant cost savings for the company.

BIBLIOGRAPHY

- CEMA, Ministry of the Environment, Government of Catalonia. *Prevençió de la contaminació al sector d'arts gràfiques*. Manuals d'ecogestió, 12. Barcelona, May 2003.
- CEMA. *Informe final dels grups de treball d'arts gràfiques a Catalunya*. Barcelona, January 2001.
- IHOBE. *Libro blanco para la minimización de residuos y emisiones*. The Basque Country, 2000.
- EPA Office of Compliance Sector Notebook Project. *Profile of the Printing and Publishing Industry*. Washington, August 1995.
- THE WORLD BANK GROUP in collaboration with UNIDO. *Pollution prevention and abatement handbook, Towards Cleaner Production*. 1998.
- RAC/CP. *State of Cleaner Production in the Mediterranean Action Plan Countries*. Barcelona, 2001.
- MINISTRY OF INDUSTRY AND ENERGY OF TUNISIA. *Étude de positionnement stratégique de la branche imprimerie*. Tunisia, December 2002.
- CONAMA RM-CENMA. *Guía para el control y la prevención de la contaminación industrial*. Santiago de Chile, August 1999.
- GENERALITAT DE CATALUNYA. *Informe anual sobre la indústria a Catalunya l'any 2001*.
- CONSEJERÍA DE MEDIO AMBIENTE de la Comunidad de Madrid. *Manual de gestión ambiental y auditoría del sector de Artes Gráficas*. Madrid, October 2000.
- WASTE MANAGEMENT & RESEARCH CENTER. *Common Pollution Prevention Practices in Printing Industry*. Illinois, 1997.
- ANCHOR. *Guía a la química en el área de prensa*. Florida, 1993.
- ANCHOR. *Guía de productos de limpieza para mantillas y rodillos de impresión*. Florida, 1993.

- ANCHOR. *Haciendo el cambio a los productos que promueven el equilibrio con la naturaleza para la limpieza de mantillas y rodillos de impresión*. Florida, 1993.
- HEIDELBERG. *Impresión & Medio Ambiente* núm. 5 y 9. Germany, April 2002.
- EPA. *Solutions for Lithographic Printers*. Washington, September 1997.
- IOWA WASTE REDUCTION CENTER. *Pollution Prevention Implementation Plan for Printing Industries*.
- IOWA WASTE REDUCTION CENTER. *Pollution Prevention Manual for Lithographic Printers*. Iowa, March 1994.
- AGFA. *Equilibrio agua/tinta*. April 1998.
- EPA DfE. *Design for the environment*. A collection of different publications on the minimisation of pollution from the different printing techniques used in the printing and allied industries.
- INGENIERÍA QUÍMICA. *Optimización de sistemas de destrucción de VOC*. April 1998.

USEFUL WEBSITES:

www.tunisieindustrie.nat.tn

Agence de promotion de l'industrie (API), Tunisia.

www.assografici.it

Associazione Nazionale Italiana Industrie Grafiche Cartotecniche e Transformatrici (Assografici), Italy.

www.ficg.fr

Fédération de l'imprimerie et de la communication graphique (FICG), France.

www.gzs.si/ENG/ccis/branch/publish/index.htm

Chamber of Commerce and Industry of Slovenia (CCIS) - Publishing and Printing Association.

<http://www.epa.gov/dfe/projects/index.htm>

US Environmental Protection Agency.

<http://www.asefapi.es/AreaPublica/AreaPublica.htm>

Spanish Association Paint and Printing Inks Manufacturers.

<http://www.iwrc.org>

Iowa Waste Reduction Center.

<http://www.pneac.org>

Printer's National Environmental Assistance Center.

<http://www.gencat.es>

Ministry of the Environment of the Government of Catalonia.

<http://www.wmrc.uiuc.edu/manuals/printing/toc.htm>

Waste Management & Research Center.

<http://www.calitrol.com>

Information on different consumable materials.

<http://www.inelme.com>

Information on different consumable materials.

<http://www.coateslorilleux.com>

Information on different consumable materials.

<http://www.varn.com/kompacII.html>

Information on different consumable materials and automatic ink fountain system.

<http://www.cambrescat.es>

General Council of Chambers of Commerce of Catalonia.

<http://www.kodak.com/US/en/corp/hse/prodSearchMSDS.html>

Safety specifications sheets on different products.

<http://graphics.agfa.com>

Sundry information.

<http://www.artesgraficas.com>

Technical and business information for the printing industry in Latin America.

<http://www.flexography.org/welcome.cfm?CFID=1946748&CFTOKEN=40312198>

Flexographic Technical Association.

<http://junres.gencat.net/junta/publicacions/pdf/dissolvents.pdf>

Waste Agency of the Government of Catalonia.

<http://www.wk-gmbh.com/espanol.html>

Control/treatment of waste gases.

<http://www.envirolink.org>

Environmental information source.

<http://www.istas.net/ma/areas/residuos/caso08.pdf>

Environmental information.

<http://www.waterless.org/NwaterWashable/default.htm>

Waterless Printing Association.

<http://www.infoserigrafia.com/>

The screen printing association.

<http://www.tecnomaq.com.mx/articulos.html>

Informative articles on types of printing.

<http://www.flexografia.com/portal/index.php>

Information - resources - business.

<http://www.aad-andalucia.org/boletin/ficheros/GLOSARIOCPG.pdf>

Technical Glossary of the Printing Industry.

http://www.mx.heidelberg.com/03_pro/frm_pro.htm

Printing press information.

RANE

tion

**Regional Activity Centre
for Cleaner Production (RAC/CP)**

París, 184, 3a planta - 08036 Barcelona (Spain)
Tel.: +34 93 415 11 12 - Fax: +34 93 237 02 86
E-mail: cleanpro@cema-sa.org
<http://www.cema-sa.org>